

HPS-42HM84AERI/I1s
HPS-84HM155AERI/I1s
HPS-120HM155AERI/I1s

HPS-22CH65AERI/O1s R32
HPS-28CH84AERI/O1s R32
HPS-34CH100AERI/O1s R32
HPS-41CH120AERI/O3s R32
HPS-48CH140AERI/O3s R32
HPS-53CH155AERI/O3s R32

EN

User manual

IMPORTANT NOTE

Thank you very much for purchasing our product,

Before using your unit , please read this manual carefully and keep it for future reference.

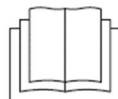

CONTENTS

| | |
|--|-----------|
| SAFETY CONSIDERATIONS | 4 |
| ACCESSORIES | 9 |
| Accessories supplied with the unit | 9 |
| BEFORE INSTALLATION | 9 |
| IMPORTANT INFORMATION FOR THE REFRIGERANT | 10 |
| INSTALLATION SITE | 11 |
| Selecting a location in cold climates | 13 |
| Prevent sunshine | 14 |
| INSTALLATION PRECAUTIONS | 14 |
| Dimensions | 14 |
| Installation requirements | 15 |
| Drain hole position | 15 |
| Servicing space requirements | 16 |
| INSTALLATION THE CONNECTING PIPE | 18 |
| Refrigerant piping | 18 |
| Leakage Detection | 19 |
| Heat insulation | 19 |
| Connecting method | 20 |
| Remove dirt or water in the pipe | 21 |
| Airtight test | 21 |
| Air Purge with Vacuum Pump | 21 |
| Refrigerant amount to be added | 22 |
| OUTDOOR UNIT WIRING | 22 |
| Precautions on wiring of power supply | 23 |
| Remove the switch box cover | 25 |
| To finish the outdoor units insulation | 26 |
| OVERVIEW OF THE UNIT | 27 |
| Disassembling the unit | 27 |
| Electronic control box | 28 |
| 4~16W Units | 29 |
| TEST RUNNING | 36 |
| PRECAUTIONS ON REFRIGERANT LEAKAGE | 36 |
| TURN OVER TO CUSTOMER | 38 |
| OPERATION AND PERFORMANCE | 35 |
| Protection equipment | 35 |
| About power cut | 35 |
| Heating capacity | 35 |
| Compressor protection feature | 35 |
| Cooling and heating operation | 36 |
| Features of heating operation | 36 |
| Defrost in the heating operation | 36 |
| Error codes | 43 |
| TECHNICAL SPECIFICATIONS | 49 |
| INFORMATION SERVICING | 51 |

Note: All the pictures in this manual are just schematic diagrams, the actual is the standard

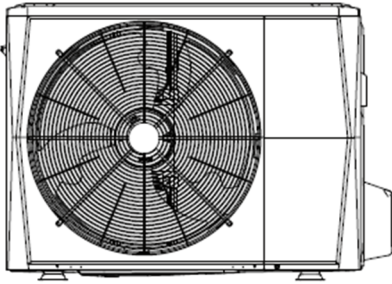

4/6 kW

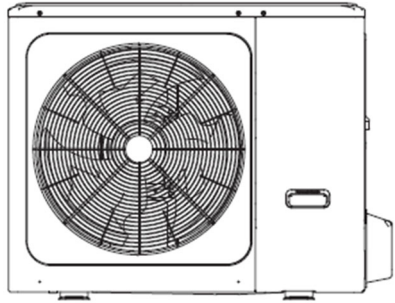

8/10/12/14/16 kW

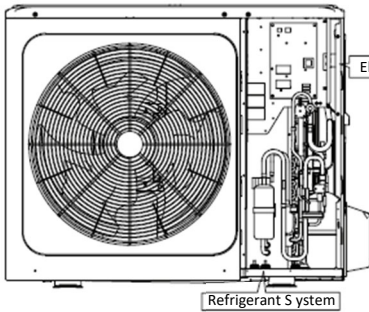

Electric Control System

Refrigerant S system

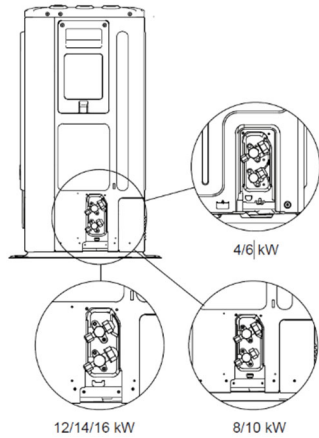

4/6 kW

12/14/16 kW

8/10 kW

Please remove the hollow plate after installation.

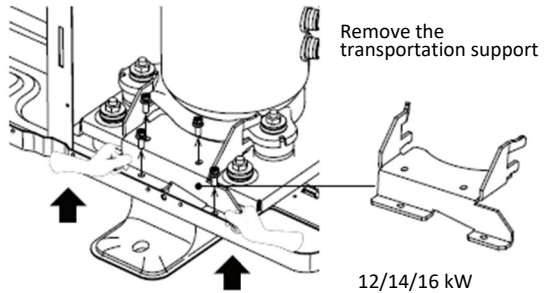
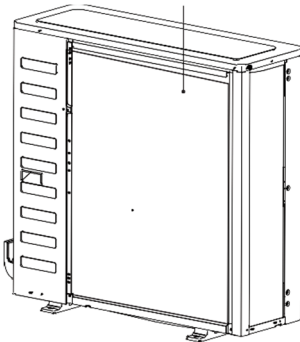

Remove the transportation support

12/14/16 kW

SAFETY PRECAUTIONS

The precautions listed here are divided into the following types. They are quite important, so be sure to follow them carefully.

Meanings of DANGER, WARNING, CAUTION and NOTE symbols.

INFORMATION

- Read these instructions carefully before installation. Keep this manual in a handy place for future reference.
- Improper installation of equipment or accessories may result in electric shock, short-circuit, leakage, fire or other damage to the equipment. Be sure to only use accessories made by the supplier, which are specifically designed for the equipment and make sure to get installation done by a professional.
- All the activities described in this manual must be carried out by a licensed technician. Be sure to wear adequate personal protection equipment such as gloves and safety glasses while installing the unit or carrying out maintenance activities.
- Contact your dealer for any further assistance.



**Caution: Risk of fire /
flammable materials.**

WARNING

Service shall only be performed as recommended by the equipment manufacturer. Maintenance and repair requiring the assistance of other skilled personnel shall be carried out under the supervision of the person competent in the use of flammable refrigerants.

DANGER

Indicates an imminently hazardous situation which if not avoided, will result in death or serious injury.

WARNING





Indicates a potentially hazardous situation which if not avoided, could result in death or serious injury.

⚠ CAUTION

Indicates a potentially hazardous situation which if not avoided, may result in minor or moderate injury.

💡 NOTE

Indicates situations that could only result in accidental equipment or property damage.

| | | |
|--|----------------|---|
|  | WARNING | This symbol shows that this appliance used a flammable refrigerant. If the refrigerant is leaked and exposed to an external ignition source, there is a risk of fire. |
|  | CAUTION | This symbol shows that the operation manual should be read carefully. |
|  | CAUTION | This symbol shows that a service personnel should be handling this equipment with reference to the installation manual. |
|  | CAUTION | This symbol shows that a service personnel should be handling this equipment with reference to the installation manual. |
|  | CAUTION | This symbol shows that information is available such as the operating manual or installation manual. |

⚠ DANGER

- Before touching electric terminal parts, turn off power switch.
- When service panels are removed, live parts can be easily touched by accident.
- Never leave the unit unattended during installation or servicing when the service panel is removed.
- Do not touch water pipes during and immediately after operation as the pipes may be hot and could burn your hands. To avoid injury, give the piping time to return to normal temperature or be sure to wear protective gloves.
- Do not touch any switch with wet fingers. Touching a switch with wet fingers can cause electrical shock.
- Before touching electrical parts, turn off all applicable power to the unit.

 **WARNING**

- Tear apart and throw away plastic packaging bags so that children will not play with them. Children playing with plastic bags face danger of death by suffocation.
- Safely dispose of packing materials such as nails and other metal or wood parts that could cause injuries.
- Ask your dealer or qualified personnel to perform installation work in accordance with this manual. Do not install the unit yourself. Improper installation could result in water leakage, electric shocks or fire.
- Be sure to use only specified accessories and parts for installation work. Failure to use specified parts may result in water leakage, electric shocks, fire, or the unit falling from its mount.
- Install the unit on a foundation that can withstand its weight. Insufficient physical strength may cause the equipment to fall and possible injury.
- Perform specified installation work with full consideration of strong wind, hurricanes, or earthquakes. Improper installation work may result in accidents due to equipment falling.
- Make certain that all electrical work is carried out by qualified personnel according to the local laws and regulations and this manual using a separate circuit. Insufficient capacity of the power supply circuit or improper electrical construction may lead to electric shocks or fire.
- Be sure to install a ground fault circuit interrupter according to local laws and regulations. Failure to install a ground fault circuit interrupter may cause electric shocks and fire.
- Make sure all wiring is secure. Use the specified wires and ensure that terminal connections or wires are protected from water and other adverse external forces. Incomplete connection or affixing may cause a fire.
- When wiring the power supply, form the wires so that the front panel can be securely fastened. If the front panel is not in place there could be overheating of the terminals, electric shocks or fire.
- After completing the installation work, check to make sure that there is no refrigerant leakage.
- Never directly touch any leaking refrigerant as it could cause severe frostbite. Do not touch the refrigerant pipes during and immediately after operation as the refrigerant pipes may be hot or cold, depending on the condition of the refrigerant flowing through the refrigerant piping, compressor and other refrigerant cycle parts. Burns or frostbite are possible if you touch the refrigerant pipes. To avoid injury, give the pipes time to return to normal temperature or, if you must touch them be sure to wear protective gloves.
- Do not touch the internal parts (pump, backup heater, etc.) during and immediately after operation. Touching the internal parts can cause burns. To avoid injury, give the internal parts time to return to normal temperature or, if you must touch them, be sure to wear protective gloves.

 **CAUTION**

- Ground the unit.
- Grounding resistance should be according to local laws and regulations.
- Do not connect the ground wire to gas or water pipes, lightning conductors or telephone ground wires.
- Incomplete grounding may cause electric shocks.
 - Gas pipes : Fire or an explosion might occur if the gas leaks.
 - Water pipes : Hard vinyl tubes are not effective grounds.
 - Lightning conductors or telephone ground wires : Electrical threshold may rise abnormally if struck by a lightning bolt.
- Install the power wire at least 3 feet (1 meter) away from televisions or radios to prevent interference or noise.
- (Depending on the radio waves, a distance of 3 feet (1 meter) may not be sufficient to eliminate the noise.)
- Do not wash the unit. This may cause electric shocks or fire. The appliance must be installed in accordance with national wiring regulations. If the supply cord is damaged, it must be replaced by the manufacturer, its service agent or similarly qualified persons in order to avoid a hazard.
- Do not install the unit in the following places:
 - Where there is mist of mineral oil, oil spray or vapors. Plastic parts may deteriorate, and cause them to come loose or water to leak.
 - Where corrosive gases (such as sulphurous acid gas) are produced. Where corrosion of copper pipes or soldered parts may cause refrigerant to leak.
 - Where there is machinery which emits electromagnetic waves. Electromagnetic waves can disturb the control system and cause equipment malfunction.
 - Where flammable gases may leak, where carbon fiber or ignitable dust is suspended in the air or where volatile flammables such as paint thinner or gasoline are handled. These types of gases might cause a fire.
 - Where the air contains high levels of salt such as near the ocean.
 - Where voltage fluctuates a lot, such as in factories.
 - In vehicles or vessels.
 - Where acidic or alkaline vapors are present.
- This appliance can be used by children 8 years old and above and persons with reduced physical, sensory or mental
- capabilities or lack of experience and knowledge if they are supervised or given instruction on using the unit in a
- safe manner and understand the hazards involved. Children should not play with the unit. Cleaning and user
- maintenance should not be done by children without supervision.
- Children should be supervised to ensure that they do not play with the appliance.

 **CAUTION**





- If the supply cord is damaged, it must be replaced by the manufacturer or its service agent or a similarly qualified person.
- **DISPOSAL:** Do not dispose this product as unsorted municipal waste. Collection of such waste separately for special treatment is necessary. Do not dispose of electrical appliances as municipal waste, use separate collection facilities. Contact your local government for information regarding the collection systems available. If electrical appliances are disposed of in landfills or dumps, hazardous substance can leak into the groundwater and get into the food chain, damaging your health and well-being.
- The wiring must be performed by professional technicians in accordance with national wiring regulation and this circuit diagram. An all-pole disconnection device which has at least 3mm separation distance in all pole and a residual current device (RCD) with the rating not exceeding 30mA shall be incorporated in the fixed wiring according to the national rule.
- Confirm the safety of the installation area (walls, floors, etc.) without hidden dangers such as water, electricity, and gas. Before wiring/pipes.
- Before installation , check whether the user's power supply meets the electrical installation requirements of unit (including reliable grounding , leakage , and wire diameter electrical load, etc.). If the electrical installation requirements of the product are not met, the installation of the product is prohibited until the product is rectified.
- When installing multiple air conditioners in a centralized manner, please confirm the load balance of the three-phase power supply, and multiple units are prevented from being assembled into the same phase of the three-phase power supply.
- Product installation should be fixed firmly, Take reinforcement measures, when necessary.

 **NOTE****About Fluorinated Gasses**

- This air-conditioning unit contains fluorinated gasses. For specific information on the type of gas and the amount, please refer to the relevant label on the unit itself. Compliance with national gas regulations shall be observed.
- Installation, service, maintenance and repair of this unit must be performed by a certified technician.
- Product uninstallation and recycling must be performed by a certified technician.
- If the system has a leak-detection system installed, it must be checked for leaks at least every 12 months. When the unit is checked for leaks, proper record-keeping of all checks is strongly recommended

ACCESSORIES

Accessories supplied with the unit

| Installation Fittings | | |
|---|---|----------|
| Name | Shape | Quantity |
| Outdoor unit installation & owners manual (this book) |  | 1 |
| Techinal data manual |  | 1 |
| Water outlet connection pipe assembly |  | 1 |
| Energy label |  | 1 |

BEFORE INSTALLATION

Before installation

Be sure to confirm the model name and the serial number of the unit.

Handling

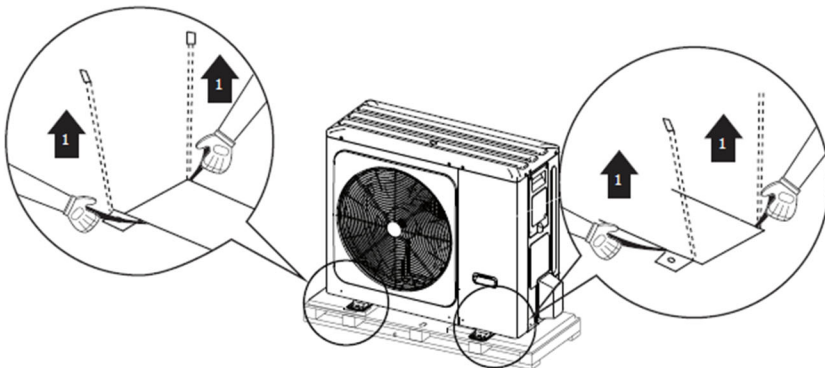

Handle the unit using the sling to the left and the handle to the right. Pull up both sides of the sling at the same time to prevent disconnection of the sling from the unit

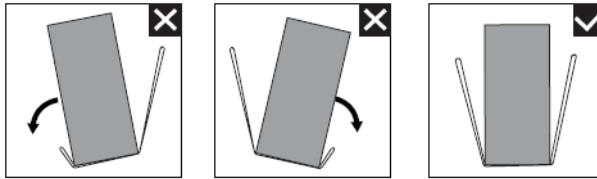

While handling the unit keep both sides of the sling level.
Keep your back straight

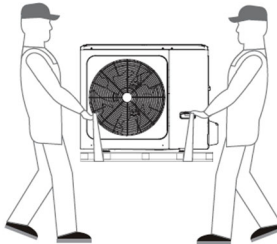

After mounting the unit, remove the sling from the unit by pulling 1 side of the sling.

⚠ CAUTION

- To avoid injury, do not touch the air inlet and aluminum fins of the unit.
- Do not use the grips in the fan grills to avoid damage.
- The unit is top heavy! Prevent the unit from falling due to improper inclination during handling.

IMPORTANT INFORMATION FOR THE REFRIGERANT

Before installation

This product has the fluorinated gas, it is forbidden to release to air.

Refrigerant type: R32; Volume of GWP: 675.

GWP=Global Warming Potential

| Model | Factory charged refrigerant volume in the unit | |
|-------|--|-----------------------|
| | Refrigerant/kg | Tonnes CO2 equivalent |
| 4kW | 1.50 | 1.02 |
| 6kW | 1.50 | 1.02 |
| 8kW | 1.65 | 1.11 |

| 10kW | 1.65 | 1.11 |
|--------------|--|-----------------------|
| Model | Factory charged refrigerant volume in the unit | |
| | Refrigerant/kg | Tonnes CO2 equivalent |
| 1-phase 12kW | 1.84 | 1.24 |
| 1-phase 14kW | 1.84 | 1.24 |
| 1-phase 16kW | 1.84 | 1.24 |
| 1-phase 12kW | 1.84 | 1.24 |
| 1-phase 14kW | 1.84 | 1.24 |
| 1-phase 16kW | 1.84 | 1.24 |

CAUTION

- Frequency of Refrigerant Leakage Checks
 - Equipment that contains less than 3 kg of fluorinated greenhouse gases or hermetically sealed equipment, which is labelled accordingly and contains less than 6 kg of fluorinated greenhouse gases shall not be subject to leak checks.
 - For unit that contains fluorinated greenhouse gases in quantities of 5 tonnes of CO2 equivalent or more, but of less than 50 tonnes of CO2 equivalent, at least every 12 months, or where a leakage detection system is installed, at least every 24 months.
 - This air-conditioning unit is a hermetically sealed equipment that contains fluorinated greenhouse gases.
 - Only certificated person is allowed to do installation, operation and maintenance.

INSTALLATION SITE

WARNING

- Be sure to adopt adequate measures to prevent the unit from being used as a shelter by small animals. Small animals making contact with electrical parts can cause malfunction, smoke or fire. Please instruct the customer to keep the area around the unit clean.
- Select an installation site where the following conditions are satisfied and one that meets with your customer's approval.
 - Places that are well-ventilated.
 - Places where the unit does not disturb next-door neighbors.
 - Safe places which can bear the unit's weight and vibration and where the unit can be installed at an even level.
 - Places where there is no possibility of flammable gas or product leak.

- The equipment is not intended for use in a potentially explosive atmosphere.
 - Places where servicing space can be well ensured.
 - Places where the units' piping and wiring lengths come within the allowable ranges.
 - Places where water leaking from the unit cannot cause damage to the location (e.g. in case of a blocked drain pipe).
 - Places where rain can be avoided as much as possible.
 - Do not install the unit in places often used as a work space. In case of construction work (e.g. grinding etc.) where a lot of dust is created, the unit must be covered.
 - Do not place any object or equipment on top of the unit (top plate)
 - Do not climb, sit or stand on top of the unit.
 - Be sure that sufficient precautions are taken in case of refrigerant leakage according to relevant local laws and regulations.
 - Don't install the unit near the sea or where there is corrosion gas.
- When installing the unit in a place exposed to strong wind, pay special attention to the following:
 - Strong winds of 5 m/sec or more blowing against the unit's air outlet causes a short circuit (suction of discharge air), and this may have the following consequences:
 - Deterioration of the operational capacity.
 - Frequent frost acceleration in heating operation.
 - Disruption of operation due to rise of high pressure.
 - Motor burnout.
 - When a strong wind blows continuously on the front of the unit, the fan can start rotating very fast until it breaks.

In normal condition, refer to the figures below for installation of the unit

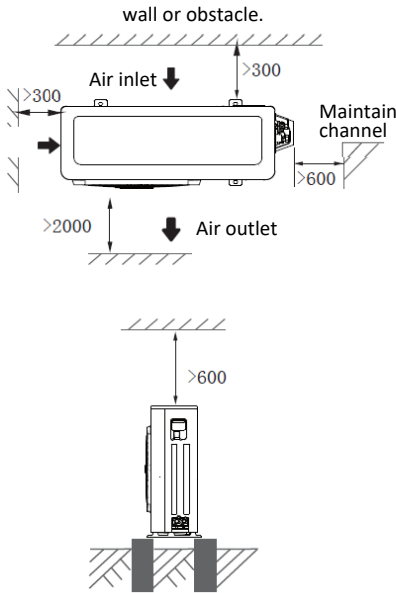

4/6/8/10/12/14/16 kW (unit: mm)

NOTE

- Make sure there is enough space to do the installation. Set the outlet side at a right angle to the direction of the wind.
- Prepare a water drainage channel around the foundation, to drain waste water from around the unit.
- If water does not easily drain from the unit, mount the unit on a foundation of concrete blocks, etc. (the height of the foundation should be about 100 mm .(in Fig:6-3)
- When installing the unit in a place frequently exposed to snow, pay special attention to elevate the foundation as high as possible.

NOTE

- If you install the unit on a building frame, please install a waterproof plate (field supply) (about 100mm, on the underside of the unit) in order to avoid drain water dripping. (See the picture in the right).



Selecting a location in cold climates

Refer to "Handling" in section „Before installation“

NOTE

When operating the unit in cold climates, be sure to follow the instructions described below.

- To prevent exposure to wind, install the unit with its suction side facing the wall.
- Never install the unit at a site where the suction side may be exposed directly to wind.
- To prevent exposure to wind, install a baffle plate on the air discharge side of the unit.
- In heavy snowfall areas, it is very important to select an installation site where the snow will not affect the unit. If lateral snowfall is possible, make sure that the heat exchanger coil is not affected by the snow (if necessary construct a lateral canopy).

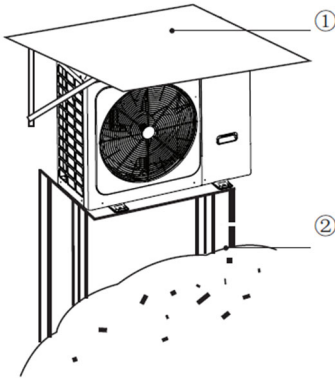

- ① Construct a large canopy.
- ② Construct a pedestal.

Install the unit high enough off the ground to prevent it from being buried in snow.

Prevent Sunshine

As the outdoor temperature is measured via the outdoor unit air thermistor, make sure to install the outdoor unit in the shade or a canopy should be constructed to avoid direct sunlight, so that it is not influenced by the sun's heat, otherwise protection may be possible to the unit.

⚠ WARNING

Uncovered scene, anti-snow shed must be installed:

- (1) To prevent rain and snow from hitting the heat exchanger, resulting in poor heating capacity of the unit, after long time accumulation, the heat exchanger freezes;
- (2) To prevent the outdoor unit air thermistor from being exposed to the sun, resulting in failure to boot;
- (3) To prevent freezing rain.

INSTALLATION PRECAUTIONS

Dimensions

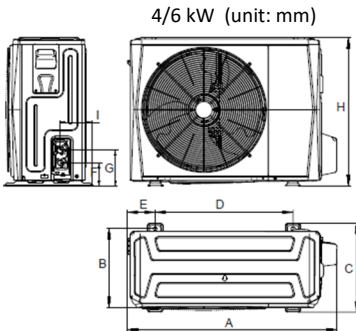

Fig 6-1

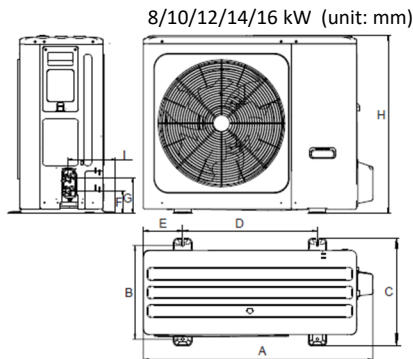

Fig 6-2

| Model | A | B | C | D | E | F | G | H | I |
|------------------|------|-----|-----|-----|-----|-----|-----|-----|-----|
| 4/6kW | 1008 | 375 | 426 | 663 | 134 | 110 | 170 | 712 | 160 |
| 8/10/12/14/16 kW | 1118 | 456 | 523 | 656 | 191 | 110 | 170 | 865 | 230 |

Installation requirements

Check the strength and level of the installation ground so that the unit may not cause any vibrations or noise during the operation.

In accordance with the foundation drawing in the figure, fix the unit securely by means of foundation bolts. (Prepare four sets each of $\Phi 10$ Expansion bolts, nuts and washers which are readily available in the market.)

Screw in the foundation bolts until their length is 20 mm from the foundation surface.

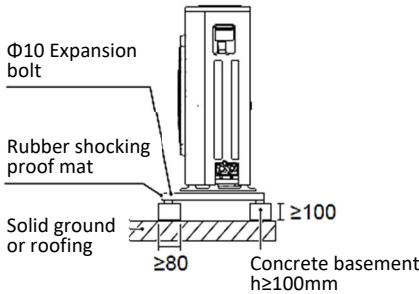

Fig 6-3

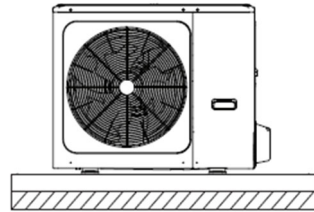
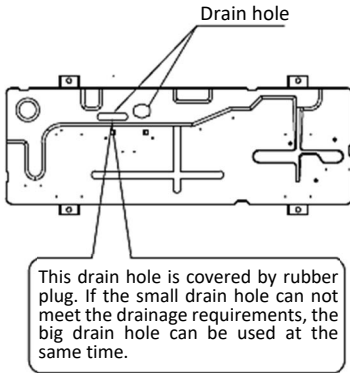
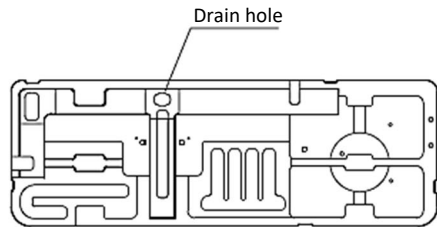

Fig 6-4

Drain hole position



4/6 kW



8/10/12/14/16 kW

Fig. 6-5

CAUTION

It's necessary to install an electrical heating belt if water can't drain out in cold weather even the big drain hole has opened.

It is suggested to site the unit with the base electric heater.

Installation space requirements

In case of stacked installation

1) In case obstacles exist in front of the outlet side

2) In case obstacles exist in front of the air inlet

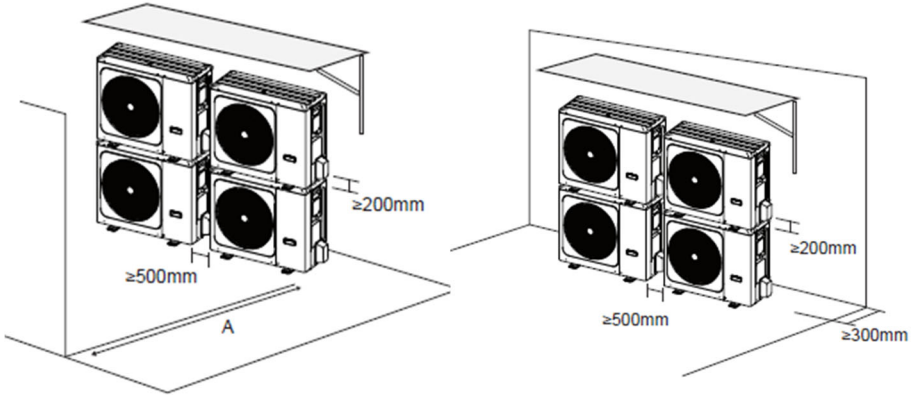

Fig. 6-6

| Unit | A(mm) |
|--------|-------|
| 4~16kW | ≥2000 |

NOTE

It's necessary to install the water outlet connection pipe assembly if the unit is mounted on the top of each other, preventing condensate flow to the heat exchanger.

In case of multiple-row installation (for roof top use, etc.)

- 1) In case of installing one unit per row.

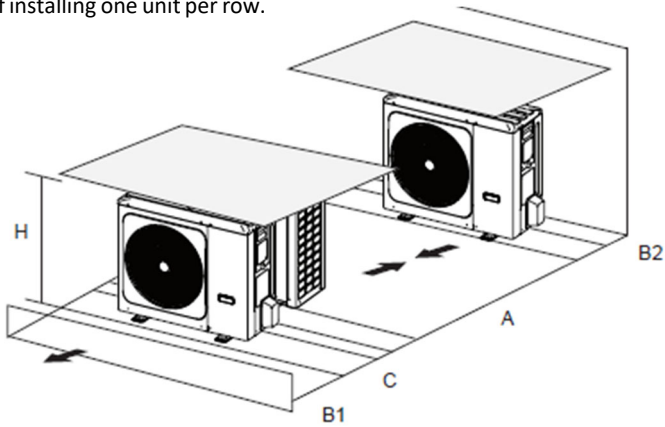

Fig. 6-7

| Unit | A(mm) | B1(mm) | B2(mm) | C(mm) |
|--------|-------|--------|--------|-------|
| 4~16kW | ≥3000 | ≥2000 | ≥150 | ≥600 |

- 1) In case of installing multiple units in lateral connection per row.

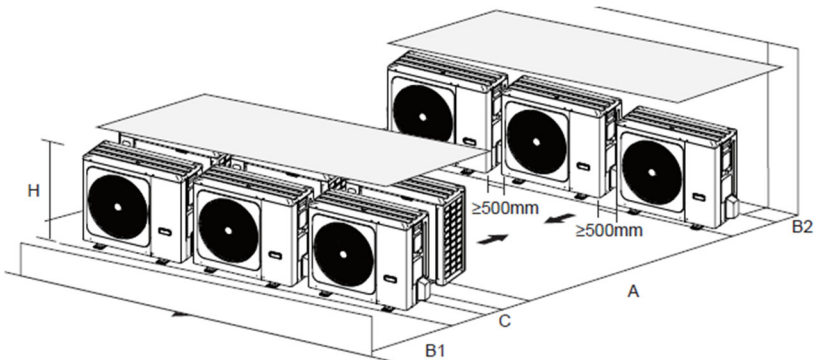

Fig. 6-8

| Unit | A(mm) | B1(mm) | B2(mm) | C(mm) |
|--------|-------|--------|--------|-------|
| 4~16kW | ≥3000 | ≥2000 | ≥300 | ≥600 |

INSTALL THE CONNECTING PIPE

Check whether the difference in height between the indoor unit and outdoor unit, the length of refrigerant pipe, and the number of the bends meet the following requirements:

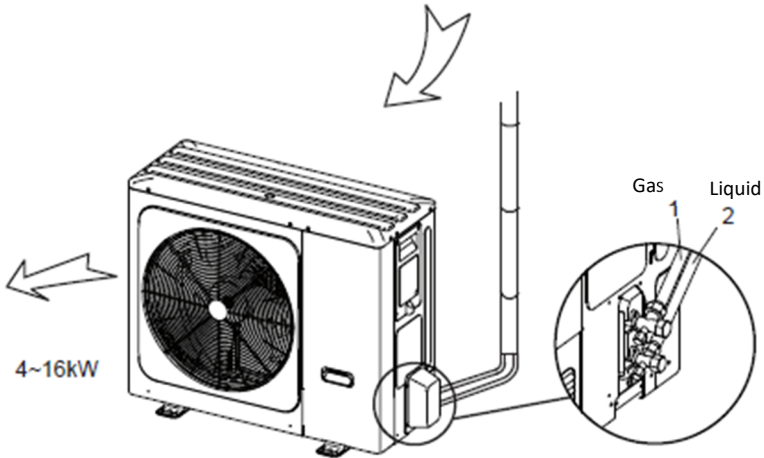

Fig. 7-1

⚠ CAUTION

- Please pay attention to avoid the components where it is connecting to the connecting pipes.
- To prevent the refrigerant piping from oxidizing inside when welding, it is necessary to charge nitrogen, or oxide will choke the circulation system.
- Back out pipe: Undersurface outlet pipe: the knock out should from inside to outside, and then piping and wiring through this. Pay attention to the piping, the fat connecting pipe should out from the largest hole, otherwise the pipes will be rubbed. Please do the moth proofing for the knocked out hole, to avoid the pest processing into and destroy the components. Please wipe off the piping support rubber blanket beside the inner outlet pipe cover of the machine while back side getting out pipes.

Leakage Detection

Use soap water or leakage detector to check every joint whether leak or not (Refer to Fig.7-2).

Note:

A is high pressure side stop valve

B is low pressure side stop valve

C and D is connecting pipes interface of indoor and outdoor units

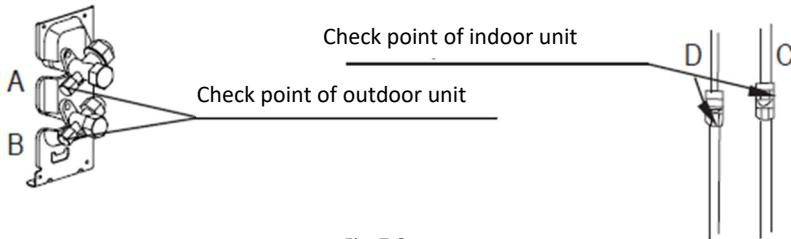

Fig. 7-2

Heat Insulation

Do the heat insulation to the pipes of gas side and liquid side separately. The temperature of the pipes of gas side and liquid side when cooling, for avoiding condensation please do the heat insulation fully.

- 1) The gas side pipe should use closed cell foamed insulation material, which the fire-retardant is B1 grade and the heat resistance over 120 °C.
- 2) When the external diameter of copper pipe $\leq \Phi 12.7\text{mm}$, the thickness of the insulating layer at least more than 15mm; When the external diameter of copper pipe $\geq \Phi 15.9\text{mm}$, the thickness of the insulating layer at least more than 20mm.
- 3) Please use attached heat-insulating materials do the heat insulation without clearance for the connecting parts of the indoor unit pipes.

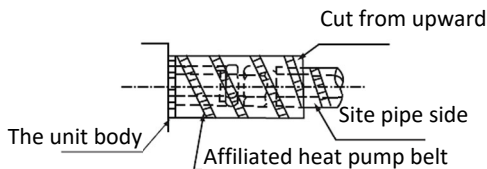
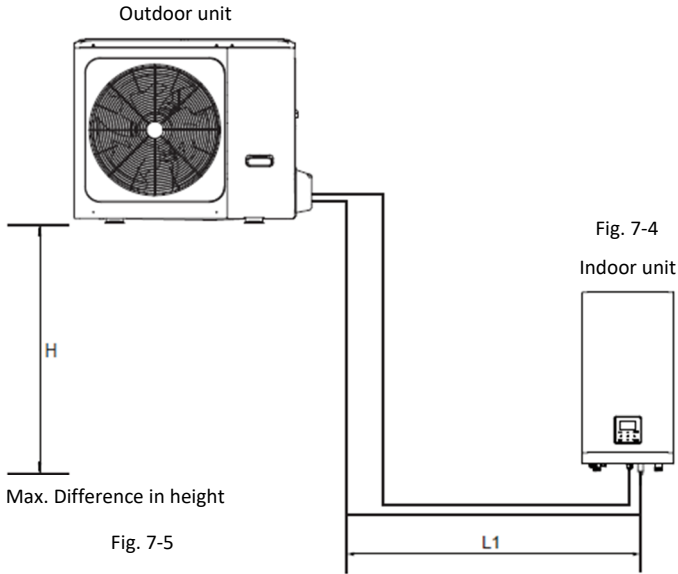

Fig. 7-3

Connecting method



CAUTION

The largest level difference between indoor unit and outdoor unit should not exceed 20m (if the outdoor unit is above) or 15m (if the outdoor unit is below). Additionally: (i) If the outdoor unit is above and the level difference is greater than 20m, it is recommended that an oil return bend with dimensions as specified in Figure 7-4 is set every 5m in the gas pipe of the main pipe; and (ii) if the outdoor unit is below and the level difference is more than 15m, the liquid pipe of the main pipe should be increased one size.

1) Size of pipes of Gas side and Liquid side

| MODEL | Refrigerant | Gas side/Liquid side |
|--------------------|-------------|----------------------|
| 4/6kW | R32 | Φ15.9 / Φ6.35 |
| 8/10kW | R32 | Φ15.9 / Φ9.52 |
| 1-phase 12/14/16kW | R32 | Φ15.9 / Φ9.52 |
| 3-phase 12/14/16kW | R32 | Φ15.9 / Φ9.52 |

2) Connection method

| | Gas side | Liquid side |
|----------------------|----------|-------------|
| 4-16 kW outdoor unit | Flaring | Flaring |
| Indoor unit | Flaring | Flaring |

| MODELS | 4-16 kW |
|------------------------------|---------|
| Max.piping length (H+L1) | 30m |
| Max difference in height (H) | 20m |

Remove Dirt or Water in the Pipes

- 1) Make sure there is no any dirt or water before connecting the piping to the outdoor and indoor units.
- 2) Wash the pipes with high pressure nitrogen, never use refrigerant of outdoor unit.

Airtight Testing

Charge pressured nitrogen after connecting indoor/outdoor unit pipes to do airtight testing

 **CAUTION**

Pressured nitrogen [4.3MPa (44kg/cm²) for R32] should be used in the airtight testing. Tighten high/low pressure valves before charging pressured nitrogen. Charge pressure nitrogen from the connector on the pressure valves. The airtight testing should never use any oxygen, flammable gas or poisonous gas.

Air Purge with Vacuum Pump

- 1) Using vacuum pump to do the vacuum, never using refrigerant to expel the air.
- 2) Vacuuming should be done from liquid side

Refrigerant Amount to be Added

Calculate the added refrigerant according to the diameter and the length of the liquid side pipe of the outdoor unit/indoor unit connection.

If the length of the liquid side pipe is less than 15 meters it is no need to add more refrigerant, so than calculating the added refrigerant the length of the liquid side pipe must subtract 15 meters

| Refrigerant to be added | MODEL | Total liquid pipe length L(m) | |
|------------------------------|-------------------|-------------------------------|------------|
| | | ≤15m | >15m |
| Total additional refrigerant | 4 / 6 kW | 0g | (L-15)×20g |
| | 8 /10/12/14/16 kW | 0g | (L-15)×38g |

OUTDOOR UNIT WIRING

WARNING

A main switch or other means of disconnection, having a contact separation in all poles, must be incorporated in the fixed wiring in accordance with relevant local laws and regulations. Switch off the power supply before making any connections. Use only copper wires. Never squeeze bundled cables and make sure they do not come in contact with the piping and sharp edges. Make sure no external pressure is applied to the terminal connections. All field wiring and components must be installed by a licensed electrician and must comply with relevant local laws and regulations.

The field wiring must be carried out in accordance with the wiring diagram supplied with the unit and the instructions given below.

Be sure to use a dedicated power supply. Never use a power supply shared by another appliance.

Be sure to establish a ground. Do not ground the unit to a utility pipe, surge protector, or telephone ground. Incomplete grounding may cause electrical shock.

Be sure to install a ground fault circuit interrupter (30 mA). Failure to do so may cause electrical shock. Be sure to install the required fuses or circuit breakers.

Precautions on electrical wiring work

- Fix cables so that cables do not make contact with the pipes (especially on the high pressure side).
- Secure the electrical wiring with cable ties as shown in figure so that it does not come in contact with the piping, particularly on the high-pressure side.
- Make sure no external pressure is applied to the terminal connectors.
- When installing the ground fault circuit interrupter make sure that it is compatible with the inverter (resistant to high frequency electrical noise) to avoid unnecessary opening of the ground fault circuit interrupter.

:

NOTE

The ground fault circuit interrupter must be a high- speed type breaker of 30 mA (<0.1s)

- This unit is equipped with an inverter. Installing a phase advancing capacitor not only will reduce the power factor improvement effect, but also may cause abnormal heating of the capacitor due to high-frequency waves. Never install a phase advancing capacitor as it could lead to an accident.

•

Precautions on wiring of power supply

- Use a round crimp-style terminal for connection to the power supply terminal board. In case it cannot be used due to unavoidable reasons, be sure to observe the following instructions.
 - Do not connect different gauge wires to the same power supply terminal. (Loose connections may cause overheating.)
 - When connecting wires of the same gauge, connect them according to the figure below.



- Use the correct screwdriver to tighten the terminal screws. Small screwdrivers can damage the screw head and prevent appropriate tightening.
- Over-tightening the terminal screws can damage the screws.
- Attach a ground fault circuit interrupter and fuse to the power supply line.
- In wiring, make certain that prescribed wires are used, carry out complete connections, and fix the wires so that outside force cannot affect the terminals

Safety device requirement

1. Select the wire diameters (minimum value) individually for each unit based on the table 8-1 and table 8-2, where the rated current in table 9-1 means MCA in table 9-2. In case the MCA exceeds 63A, the wire diameters should be selected according to the national wiring regulation.
2. Select circuit breaker that having a contact separation in all poles not less than 3 mm providing full disconnection, where MFA is used to select the current circuit breakers and residual current operation breakers:

| Rated current of appliance:(A) | Nominal cross-sectional area (mm ²) | |
|--------------------------------|---|------------------------|
| | Flexible cords | Cable for fixed wiring |
| ≤3 | 0.5 and 0.75 | 1 and 2.5 |
| >3 and ≤6 | 0.75 and 1 | 1 and 2.5 |
| >6 and ≤10 | 1 and 1.5 | 1 and 2.5 |
| >10 and ≤16 | 1.5 and 2.5 | 1.5 and 4 |
| >16 and ≤25 | 2.5 and 4 | 2.5 and 6 |
| >25 and ≤32 | 4 and 6 | 4 and 10 |
| >32 and ≤50 | 6 and 10 | 6 and 16 |
| >50 and ≤63 | 10 and 16 | 10 and 25 |

Fig. 8-1

| System | Outdoor Unit | | | | Power Current | | | Compressor | | Compressor | |
|-----------|--------------|----|----------|----------|---------------|----------|---------|------------|---------|------------|---------|
| | Voltage (V) | Hz | Min. (V) | Max. (V) | MCA (A) | TOCA (A) | MFA (A) | MSC (A) | RLA (A) | KW | FLA (A) |
| 4kW | 220-240 | 50 | 198 | 264 | 12 | 18 | 25 | - | 11.50 | 0.10 | 0.50 |
| 6kW | 220-240 | 50 | 198 | 264 | 14 | 18 | 25 | - | 13.50 | 0.10 | 0.50 |
| 8kW | 220-240 | 50 | 198 | 264 | 16 | 19 | 25 | - | 14.50 | 0.17 | 1.50 |
| 10kW | 220-240 | 50 | 198 | 264 | 17 | 19 | 25 | - | 15.50 | 0.17 | 1.50 |
| 12kW | 220-240 | 50 | 198 | 264 | 25 | 30 | 35 | - | 23.50 | 0.17 | 1.50 |
| 14kW | 220-240 | 50 | 198 | 264 | 26 | 30 | 35 | - | 24.50 | 0.17 | 1.50 |
| 16kW | 220-240 | 50 | 198 | 264 | 27 | 30 | 35 | - | 25.50 | 0.17 | 1.50 |
| 12kW 3-PH | 380-415 | 50 | 342 | 456 | 10 | 14 | 16 | - | 9.15 | 0.17 | 1.50 |

| | | | | | | | | | | | |
|-----------|---------|----|-----|-----|----|----|----|---|-------|------|------|
| 14kW 3-PH | 380-415 | 50 | 342 | 456 | 11 | 14 | 16 | - | 10.15 | 0.17 | 1.50 |
| 16kW 3-PH | 380-415 | 50 | 342 | 456 | 12 | 14 | 16 | - | 11.15 | 0.17 | 1.50 |

 **NOTE**

- MCA :** Max. Circuit Amps. (A)
- TOCA :** Total Over-current Amps. (A)
- MFA :** Max. Fuse Amps. (A)
- MSC :** Max. Fuse Amps. (A)
- FLA :** In nominal cooling or heating test condition, the input Amps of compressor where MAX. Hz can operate Rated Load Amps. (A);
- KW :** Rated Motor Output
- FLA :** Full Load Amps. (A)

Remove the switch box cover

| Unit (kW) | 4 kW | 6 kW | 8 kW | 10 kW | 12 kW | 14 kW | 16 kW | 12kW-3-PH | 14kW-3-PH | 16kW-3-PH |
|---|---------------------|---------------------|---------------------|---------------------|---------------------|---------------------|---------------------|---------------------|---------------------|---------------------|
| Maximum overcurrent protector (MOP) (A) | 18 A | 18 A | 19 A | 19 A | 30 A | 30 A | 30 A | 14 A | 14 A | 14 A |
| Wiring size (mm ²) | 4.0 mm ² | 4.0 mm ² | 4.0 mm ² | 4.0 mm ² | 6.0 mm ² | 6.0 mm ² | 6.0 mm ² | 2.5 mm ² | 2.5 mm ² | 2.5 mm ² |

Stated values are maximum values (see electrical data for exact values).

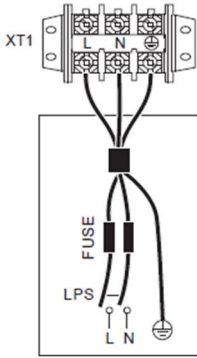

Outdoor Unit
Power supply
1-phase

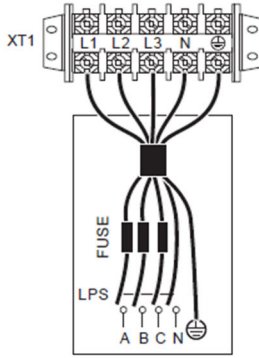

Outdoor Unit
Power supply
3-phase

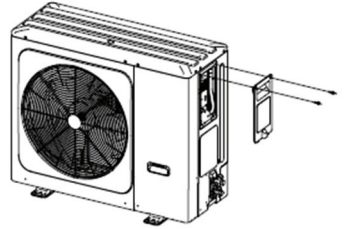

NOTE

The ground fault circuit interrupter must be a high-speed type breaker of 30 mA (<0.1s). Please use 3-core shielded wire.

To finish the outdoor unit installation

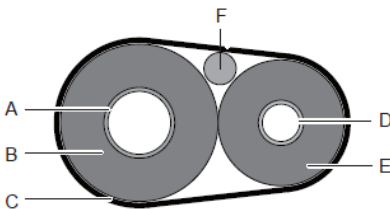

| | |
|---|------------------------|
| A | Gas pipe |
| B | Gas pipe insulation |
| C | Finishing tip |
| D | Liquid pipe |
| E | Liquid pipe insulation |
| F | Interconnection cable |

OVERVIEW OF THE UNIT

Disassembling the unit

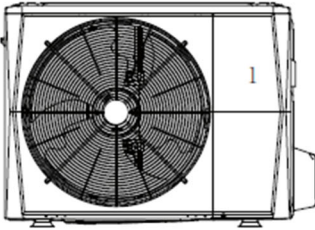

4/6 kW

Door 1: To access to the compressor and electrical parts

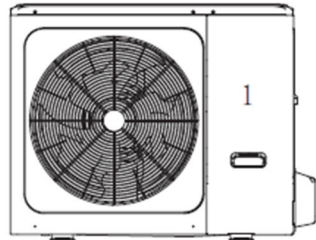

8/10/12/14/16 kW

Door 1: To access to the compressor and electrical parts

WARNING

- Switch off all power — i.e. unit power supply and backup heater and domestic hot water tank power supply (if applicable) — before removing doors 1.
- Parts inside the unit may be hot.

Push the grill to the left until it stops, then pull its right edge, so you can removed the grill. You can also reverse the procedure. Be careful to avoid hand injury.

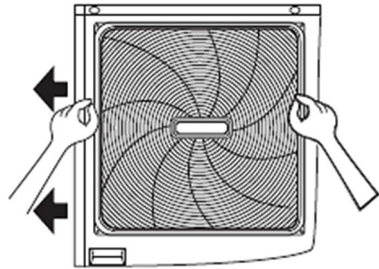
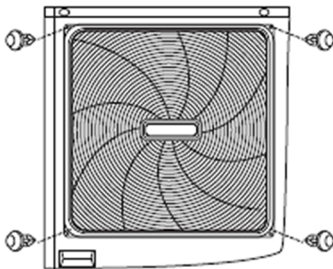

Electronic control box

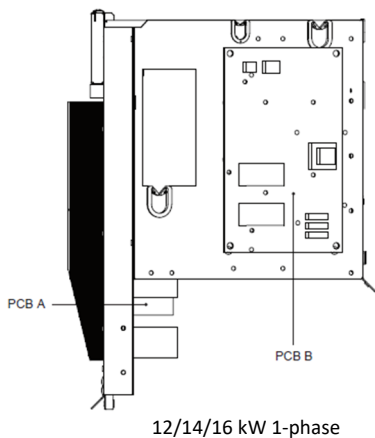
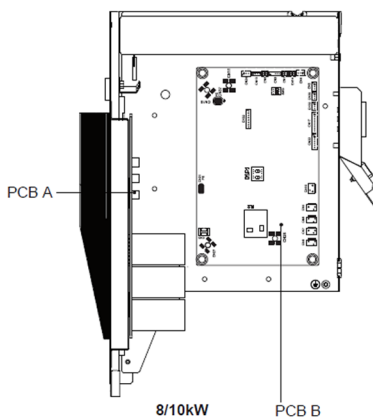
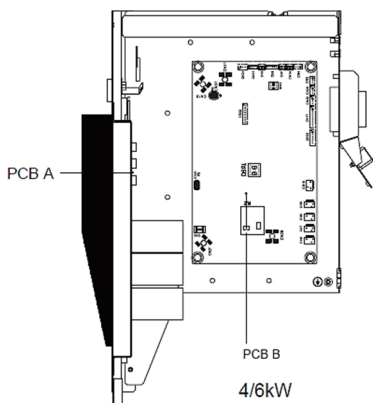

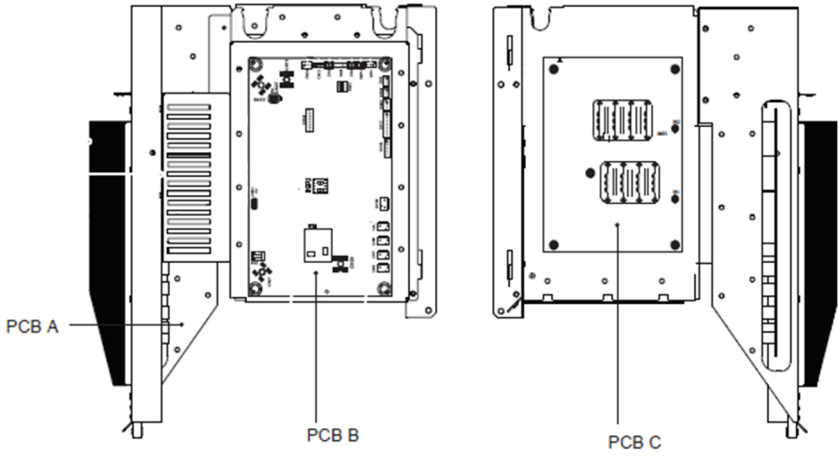

12/14/16kW 3-phase

NOTE

The picture is for reference only, please refer to the actual product.

4~16kW 1-phase units

- 1) **PCB A**, 4-10 kW
Inverter module

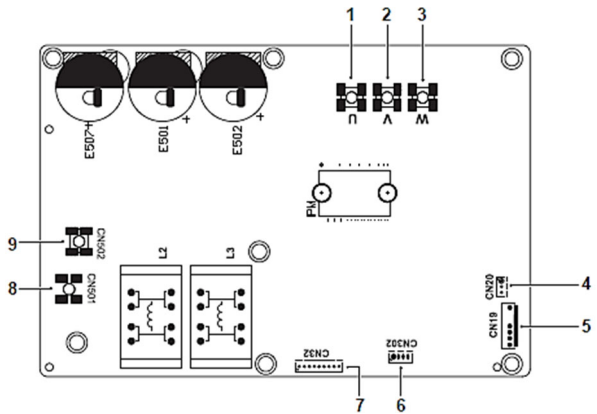

| Coding | Assembly unit | Coding | Assembly unit |
|--------|-------------------------------|--------|--|
| 1 | Compressor connection port U | 6 | Reserved(CN302) |
| 2 | Compressor connection port V | 7 | Port for communication with PCB B(CN32) |
| 3 | Compressor connection port W | 8 | Input port N for rectifier bridge(CN502) |
| 4 | Output port for +12V/9V(CN20) | 9 | Input port L for rectifier bridge(CN501) |
| 5 | Port for fan(CN19) | / | / |

2) PCB A, 12-16 kW Inverter module

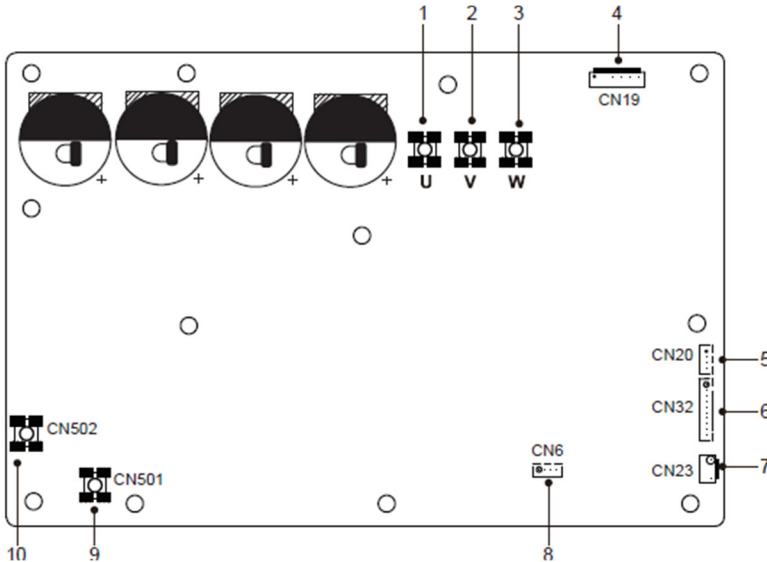

| Coding | Assembly unit | Coding | Assembly unit |
|--------|-------------------------------|--------|---|
| 1 | Compressor connection port U | 6 | Port for communication with PCB B(CN32) |
| 2 | Compressor connection port V | 7 | Port for high pressure switch (CN23) |
| 3 | Compressor connection port W | 8 | Reserved(CN6) |
| 4 | Port for fan(CN19) | 9 | Input port N for rectifier bridge (CN501) |
| 5 | Output port for +12V/9V(CN20) | 10 | Input port N for rectifier bridge (CN502) |

3) PCB B, 4-16 kW Main Control Board

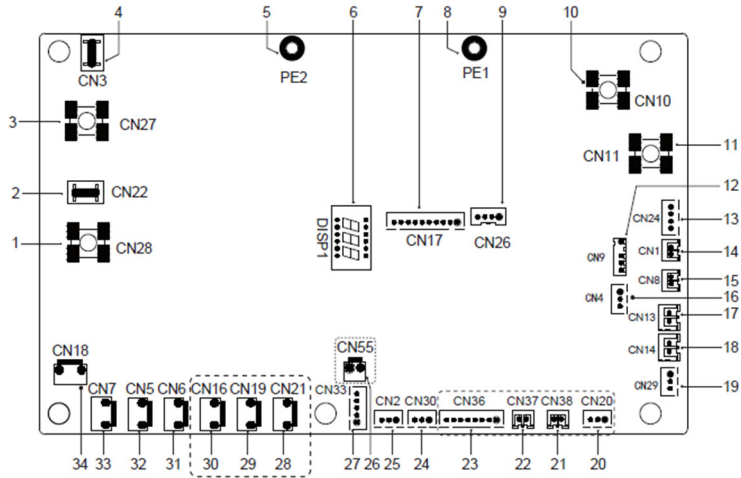

| Coding | Assembly unit | Coding | Assembly unit |
|--------|--|--------|--|
| 1 | Output port L to PCB A(CN28) | 18 | Port for low pressure switch (CN14) |
| 2 | Reserved(CN22) | 19 | Port for communication with hydro-box control board (CN29) |
| 3 | Output port N to PCB A(CN27) | 20 | Reserved(CN20) |
| 4 | Reserved(CN3) | 21 | Reserved(CN38) |
| 5 | Port for ground wire(PE2) | 22 | Reserved(CN37) |
| 6 | Digital display(DSP1) | 23 | Reserved(CN36) |
| 7 | Port for communication with PCB A(CN17) | 24 | Port for communication(reserved,CN30) |
| 8 | Port for ground wire(PE1) | 25 | Port for communication(reserved,CN2) |
| 9 | Reserved(CN26) | 26 | Reserved(CN55) |
| 10 | Input port for neutral wire(CN10) | 27 | Port for electrical expansion valve(CN33) |
| 11 | Input port for live wire(CN11) | 28 | Reserved(CN21) |
| 12 | Port for outdoor ambient temp. sensor and condenser temp.sensor(CN9) | 29 | Reserved(CN19) |
| 13 | Input port for +12V/9V(CN24) | 30 | Port for chassis electrical heating tape(CN16)(optional) |

| | | | |
|----|--------------------------------------|----|--|
| 14 | Port for sunction temp.sensor(CN1) | 31 | Port for 4-way valve(CN6) |
| 15 | Port for discharge temp.sensor(CN8) | 32 | Port for SV6 valve(CN5) |
| 16 | Port for pressure sensor(CN4) | 33 | Port for compressor eletric heating tape 1(CN7) |
| 17 | Port for high pressure switch (CN13) | 34 | Port for compressor eletric heating tape 2(CN18) |

12~16kW 1-phase units

1) PCB A, Inverter module

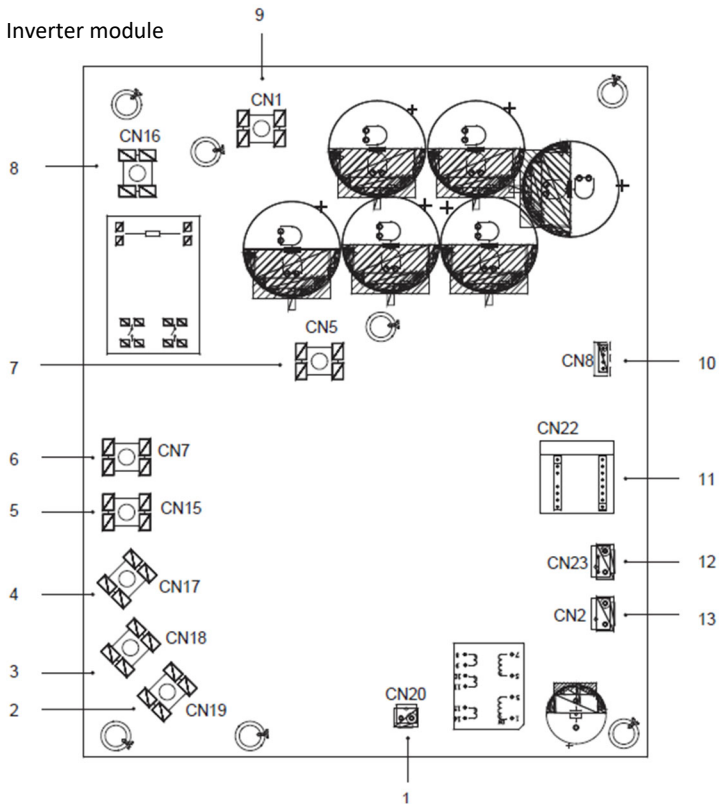

| Coding | Assembly unit | Coding | Assembly unit |
|--------|------------------------------------|--------|---|
| 1 | Output port for +15V(CN20)) | 8 | Power Input port L1(CN16) |
| 2 | Compressor connection port W(CN19) | 9 | Input port P_in for IPM module(CN1) |
| 3 | Compressor connection port V(CN18) | 10 | Port for communication with PCB B (CN8) |

| | | | |
|---|--------------------------------------|----|--|
| 4 | Compressor connection port U(CN17) | 11 | PED board(CN22) |
| 5 | Power Input port L3(CN15) | 12 | Port for high pressure switch (CN23) |
| 6 | Power Input port L2(CN7) | 13 | Port for communication with PCB C(CN2) |
| 7 | Input port P_out for IPM module(CN5) | | |

2) **PCB B, Main Control Board**

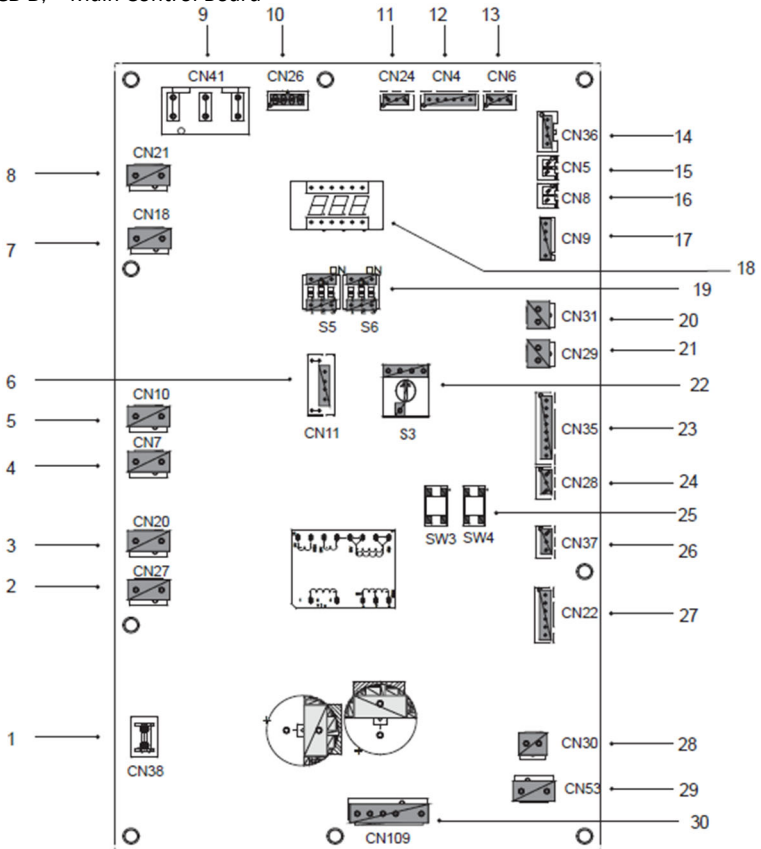

| Coding | Assembly unit | Coding | Assembly unit |
|--------|------------------------------|--------|--|
| 1 | Port for ground wire(CN38) | 16 | Port for temp.sensor Tp(CN8) |
| 2 | Port for 2-way valve 6(CN27) | 17 | Port for outdoor ambient temp. sensor and condenser temp.sensor(CN9) |

| | | | |
|----|--|----|---|
| 3 | Port for 2-way valve 5(CN20) | 18 | Digital display(DSP1) |
| 4 | Port for electric heating tape2(CN7) | 19 | DIP switch(S5,S6) |
| 5 | Port for electric heating tape1(CN10) | 20 | Port for low pressure switch(CN31) |
| 6 | Reserved(CN11) | 21 | Port for high pressure switch and quick check(CN29) |
| 7 | Port for 4-way valve(CN18) | 22 | Rotary dip switch(S3) |
| 8 | Reserved(CN21) | 23 | Port for temp.sensors(TW_out, TW_in, T1, T2,T2B)(CN35)(Reserved) |
| 9 | Power supply port from PCB C(CN41) | 24 | Port for communication XYE(CN28) |
| 10 | Port for communication with Power Meter(CN26) | 25 | Key for force cool&check(S3,S4) |
| 11 | Port for communication with hydro-box control board (CN24) | 26 | Port for communication H1H2E(CN37) |
| 12 | Port for communication with PCB C(CN4) | 27 | Port for electrical expansion valve(CN22) |
| 13 | Port for pressure sensor(CN6) | 28 | Port for fan 15VDC power supply(CN30) |
| 14 | Port for communication with PCB A(CN36) | 29 | Port for fan 310VDC power supply(CN53) |
| 15 | Port for temp.sensor Th(CN5) | 30 | Port for fan(CN109) |

3) PCB C 3-phase 12/14/16kW, Filter Board

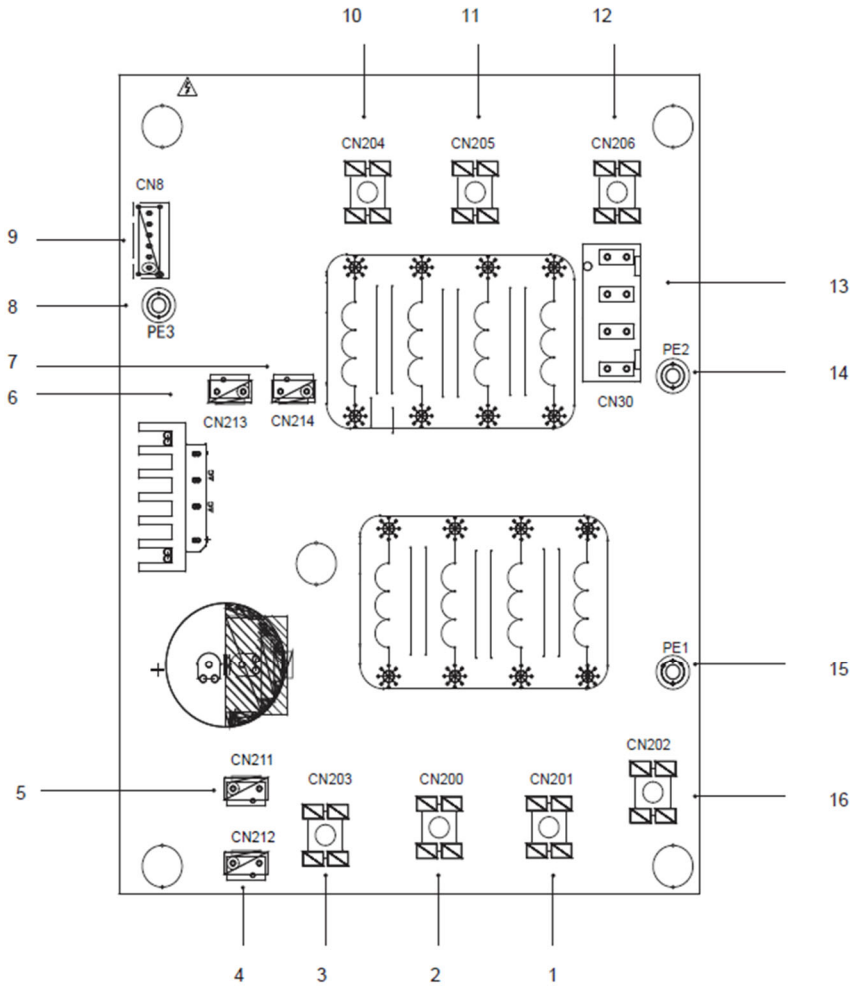

| Coding | Assembly unit | Coding | Assembly unit |
|--------|------------------------------------|--------|---|
| 1 | Power supply L2(CN201) | 9 | Port for communication with PCB B (CN8) |
| 2 | Power supply L3(CN200) | 10 | Power filtering L3(L3') |
| 3 | Power supply N(CN203) | 11 | Power filtering L2(L2') |
| 4 | Power supply port of 310VDC(CN212) | 12 | Power filtering L1(L1') |

| | | | |
|---|--|----|--|
| 5 | Reserved(CN211) | 13 | Power supply port for main control board(CN30) |
| 6 | Port for FAN Reactor(CN213) | 14 | Port for ground wire(PE2) |
| 7 | Power supply port for Inverter module(CN214) | 15 | Port for ground wire(PE1) |
| 8 | Ground wire(PE3) | 16 | Power supply L1(L1) |

TEST RUNNING

Operate according to "key points for test running" on the electric control box cover.

CAUTION

- Test running can not start until the outdoor unit has been connected to the power for 12 hours.
- Test running can not start until all the valves are affirmed open.

PRECAUTIONS ON REFRIGERANT LEAKAGE

When the refrigerant charge in appliance is more than 1.842kg, following requirements should be complied with.

Requirements for charge limits in unventilated areas:

The maximum refrigerant charge in appliance shall be in accordance with the following:

$$m_{\max} = 2.5 \times (\text{LFL})^{5/4} \times 1.8 \times (\text{A})^{1/2}$$

or the required minimum floor area A_{\min} to install an appliance with refrigerant charge m_c shall be in accordance with following:

$$A_{\min} = (m_c / (2.5 \times (\text{LFL})^{5/4} \times 1.8))^2$$

where

m_{\max} is the allowable maximumm charge in a room, in kg

A is the room area, in m^2

A_{\min} is the required minimum room area ,in m^2

m_c is the refrigerant charge in appliance, in kg

LFL is the lower flammable limit in kg/m^3 ,the value is 0.306 for R32 refrigerant

- Install mechanical ventilator to reduce the refrigerant thickness, under critical level. (ventilate regularly).

- Install leak alarm facility related to mechanical ventilator if you can not regularly ventilate.

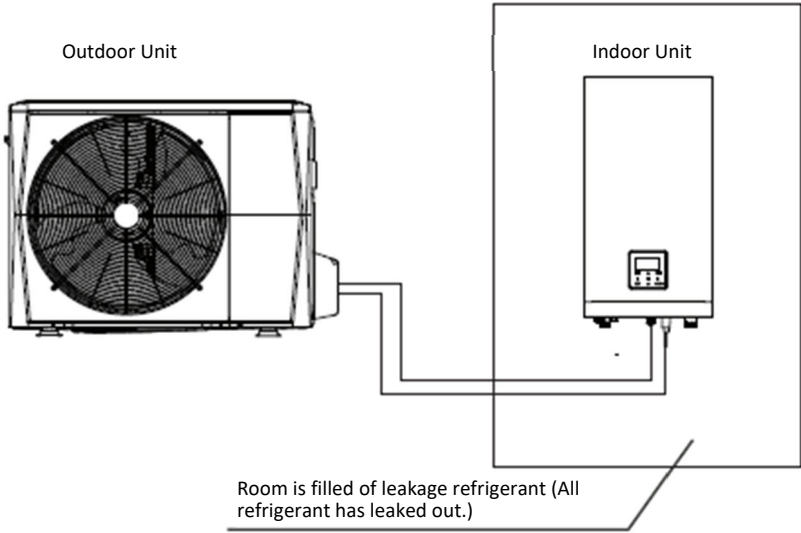

4/6kW

Fig 11-1

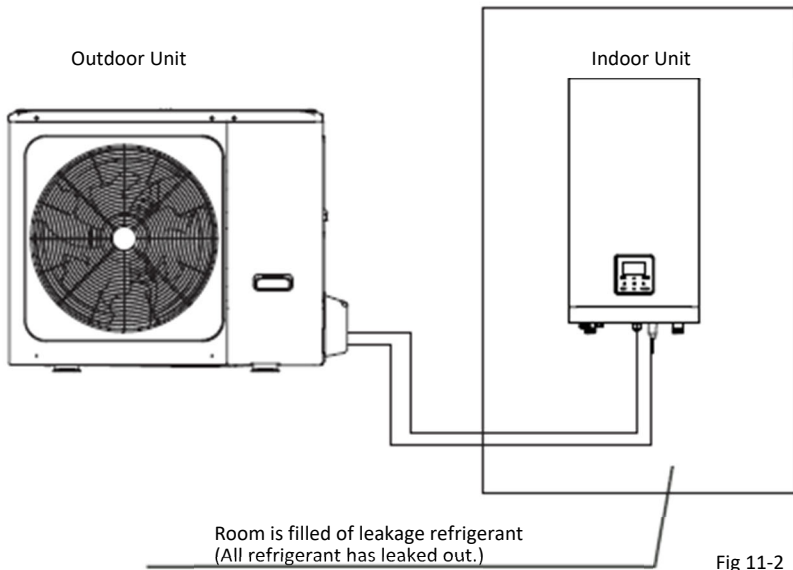

8/10/12/14/16 kW

Fig 11-2

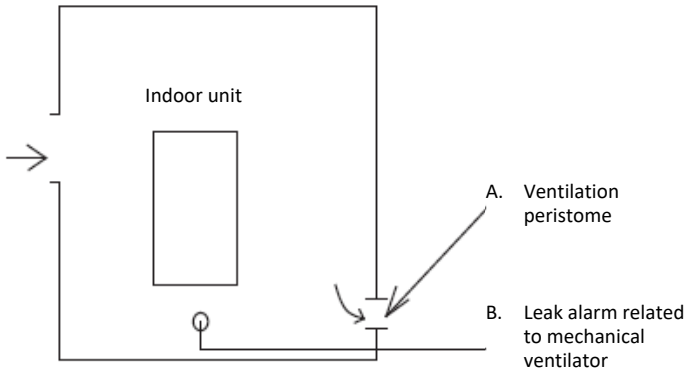

Leak hunting siren should be installed in places easily keep refrigerant)

Fig 11-3

TURN OVER TO CUSTOMER

The owner's manual of indoor unit and owner's manual of outdoor unit must be turned over to the customer. Explain the contents in the owner's manual to the customers in details.

 **WARNING**

- **Ask your dealer for installation of the heat pump.** Incomplete installation performed by yourself may result in a water leakage, electric shock, and fire.
- **Ask your dealer for improvement, repair, and maintenance.**
- Incomplete improvement, repair, and maintenance may result in a water leakage, electric shock, and fire.
- **In order to avoid electric shock, fire or injury, or if you detect any abnormality such as smell of fire, turn off the power supply and call your dealer for instructions.**
- **Never let the indoor unit or the remote controller get wet.** It may cause an electric shock or a fire.
- **Never press the button of the remote controller with a hard, pointed object.** The remote controller may be damaged.
- **Never replace a fuse with that of wrong rated current or other wires when a fuse blows out.** Use of wire or copper wire may cause the unit to break down or cause a fire.
- **It is not good for your health to expose your body to the air flow for a long time.**
- **Do not insert fingers, rods or other objects into the air inlet or outlet.** When the fan is rotating at high speed, it will cause injury.
- **Never use a flammable spray such as hair spray, lacquer or paint near the unit.** It may cause a fire.
- **Never put any objects into the air inlet or outlet.** Objects touching the fan at high speed can be dangerous.

- **Do not dispose this product as unsorted municipal waste.**  **Collection of such waste separately for special treatment is necessary.**

Do not dispose of electrical appliances as unsorted municipal waste, use separate collection facilities. Contact your local government for information regarding the connection systems available.

- **If electrical appliances are disposed of in landfills or dumps, hazardous substances can leak into the ground and get into the food chain, damaging your health and well-being.**
- **To prevent refrigerant leak, contact your dealer.**
- When the system is installed and runs in a small room, it is required to keep the concentration of the refrigerant, if by any chance coming out, below the limit. Otherwise, oxygen in the room may be affected, resulting in a serious accident.
- **The refrigerant in the heat pump is safe and normally does not leak.** If the refrigerant leaks in the room, contact with a fire of a burner, a heater or a cooker may result in a harmful gas
- **Turn off any combustible heating devices, ventilate the room, and contact the dealer where you purchased the unit.** Do not use the heat pump until a service person confirms that the portion where the refrigerant leaks is repaired.

 **CAUTION**

- **Do not use the heat pump for other purposes.**
- In order to avoid any quality deterioration, do not use the unit for cooling precision instruments, food, plants, animals or works of art.
- **Before cleaning, be sure to stop the operation, turn the breaker off or pull out the supply cord.**
- Otherwise, an electric shock and injury may result.
- **In order to avoid electric shock or fire, make sure that an earth leak detector is installed.**
- **Be sure the heat pump is grounded.**
- In order to avoid electric shock, make sure that the unit is grounded and that the earth wire is not connected to gas or water pipe, lightning conductor or telephone earth wire.
- **In order to avoid injury, do not remove the fan guard of the outdoor unit.**
- **Do not operate the heat pump with a wet hand.**
- An electric shock may happen.
- **Do not touch the heat exchanger fins.**
- These fins are sharp and could result in cutting injuries.
- **Do not place items which might be damaged by moisture under the indoor unit.**
- Condensation may form if the humidity is above 80%, the drain outlet is blocked or the filter is polluted.
- **After a long use, check the unit stand and fitting for damage.**

- If damaged, the unit may fall and result in injury.
- **To avoid oxygen deficiency, ventilate the room sufficiently if equipment with burner is used together with the heat pump.**
- **Arrange the drain hose to ensure smooth drainage.** Incomplete drainage may cause wetting of the building, furniture etc.
- **Never touch the internal parts of the controller.**
- Do not remove the front panel. Some parts inside are dangerous to touch, and a machine trouble may happen.
- **Never do the maintenances work by yourself.**
- Please contact your local dealer to do the maintenances work.
- Never expose little children, plants or animals directly to the air flow.
- Adverse influence to little children, animals and plants may result.
- Do not allow a child to mount on the outdoor unit or avoid placing any object on it.
- Falling or tumbling may result in injury.
- Do not operate the heat pump when using a room fumigation - type insecticide.
- Failure to observe could cause the chemicals to become deposited in the unit, which could endanger the health of those who are hypersensitive to chemicals.
- Do not place appliances which produce open fire in places exposed to the air flow from the unit or under the indoor unit.
- It may cause incomplete combustion

or deformation of the unit due to the heat.

- Do not install the heat pump at any place where flammable gas may leak out.
- If the gas leaks out and stays around the heat pump, a fire may break out.
- The appliance is not intended for use by young children or infirm persons without supervision.
- Young children should be supervised to ensure that they do not play with the appliance.
- The outdoor unit window-shades should be periodic cleaning in case of being jammed.
- This window-shapes is heat dissipation outlet of components, if being jammed will cause the components shorten their service life spans because of overheated for a long time.
- The temperature of refrigerant circuit will be high, please keep the interconnection cable away from the copper tube.

OPERATION AND PERFORMANCE

Protection Equipment

This Protection Equipment will enable the Heat Pump to stop when the Heat Pump is to be directed running compulsively.

The protection equipment may be activated in following conditions:

Cooling Operation

- The air inlet or air outlet of outdoor unit is blocked.

- Strong wind is Continuously blowing to the air outlet of the outdoor unit.

Heating Operation

- Too much rubbish adhere to the filter in the water system
- The air outlet of indoor unit is choked
- Mishandling in operation:
If mishandling happens because of lighting or mobile wireless, please shut off the manual power switch, and turn on again, then push the ON/OFF button

NOTE

When the protection equipment starts, please shut down the manual power switch, and restart operation after problem is solved.

About Power Cut

- If power is cut during operation, stop all the operation immediately
- Power comes again. If the auto-restart function is set on, then the unit will auto-restart.

Heating capacity

- The heating operation is a heat-pump process that heat will be absorbed from outdoor air and released to indoor water. Once the outdoor temperature is decreased, heating capacity decreased correspondingly.
- Other heating equipment is suggested to be used together when outdoor temperature is too low.

- In some extreme cold upland that buy the indoor unit equipped with electrical heater will obtain better performance.(Refer to indoor unit owner's manual for details)

⚠ NOTE

The motor in outdoor Unit will continue running for 60 seconds for to remove residual heat when the outdoor Unit receiveing OFF command during heating operation.

If the heat pump malfunction occurs because of disturb, please reconnect the heat pump to power, then turn on it again.

Compressor protection feature

- A protection feature prevents the heat pump from being activated for approximately several minutes when it restarts immediately after operation.

Cooling and heating operation

- The the indoor unit in the same system can not run cooling and heating at the same time.
- If the Heat Pump Administrator has set running mode, then the heat pump can not run on modes other than the presetted. Standby or No Priority will be displayed in the Control Panel.

Features of heating operation

- Water will not become hot immediately at the beginning of the heating operation, 3~5 minutes ago (depends on the indoor and outdoor temperature), until the indoor heat exchanger become hot, then becomes hot.

- During operation, the fan motor in the outdoor unit may stop running under high temperature.

Defrost in the heating operation

- During heating operation, outdoor unit sometimes will frost. To increase efficiency, the unit will start defrosting automatically (about 2~10 minutes), and then water will be drained out from outdoor unit.
- During defrosting, the fan motors in the outdoor unit will stop running.

Error codes

When a safety device is activated, an error code will be displayed on the user interface.

A list of all errors and corrective actions can be found in the table below.

Reset the safety by turning the unit OFF and back ON.

In case this procedure for resetting the safety is not successful, contact your local dealer.

| ERROR CODE | MALFUNCTION OR PROTECTION | FAILURE CAUSE AND CORRECTIVE ACTION |
|------------|--|---|
| <i>E1</i> | Phase loss or neutral wire and live wire are connected reversely(only for three phase unit). | <ol style="list-style-type: none"> 1. Check the power supply cables should be conneted stable,aviod phase loss. 2. Check whether the sequence of neutral wire and live wire are connected reversely. |
| <i>E5</i> | The condenser outlet refrigerant temperature sensor (T3)error. | <ol style="list-style-type: none"> 1. The T3 sensor connector is loosen. Reconnect it. 2. The T3 sensor connector is wet or there is water in. remove the water, make the connector dry. Add waterproof adhesive 3. The T3 sensor failure, change a new sensor. |
| <i>E6</i> | The ambient temperature sensor (T4) error. | <ol style="list-style-type: none"> 1. The T4 sensor connector is loosen. Reconnect it. 2. The T4 sensor connector is wet or there is water in. remove the water, make the connector dry. Add waterproof adhesive 3. The T4 sensor failure, change a new sensor. |
| <i>E9</i> | Suction temperature sensor(Th) error | <ol style="list-style-type: none"> 1. The Th sensor connector is loosen. Re connect it. 2. The Th sensor connector is wet or there is water in. remove the water, make the connector dry. Add waterproof adhesive 3. The Th sensor failure, change a new sensor. |
| <i>EA</i> | Discharge temperature sensor(Tp) error | <ol style="list-style-type: none"> 1. The Tp sensor connector is loosen. Re connect it. 2. The Tp sensor connector is wet or there is water in. remove the water, make the connector dry. Add waterproof adhesive 3. The Tp sensor failure, change a new sensor. |

| | | |
|-----------|---|--|
| <p>H0</p> | <p>Communication fault between indoor unit and outdoor unit</p> | <ol style="list-style-type: none"> 1. wire doesn't connect between main control board PCB B and main control board of hydraulic module. connect the wire. 2. Communication wire sequence is not right. Reconnect the wire in the right sequence. 3. Whether there is a high magnetic field or high power interfere, such as lifts, large power transformers, etc.. To add a barrier to protect the unit or to move the unit to the other place. |
| <p>H1</p> | <p>Communication error between inverter module PCB A and main control board PCB B</p> | <ol style="list-style-type: none"> 1. Whether there is power connected to the PCB and driven board. Check the PCB indicator light is on or off. If Light is off, reconnect the power supply wire. 2. if light is on, check the wire connection between the main PCB and driven PCB, if the wire loosen or broken, reconnect the wire or change a new wire. 3. Replace a new main PCB and driven board in turn. |
| <p>H4</p> | <p>Three times P6 protect</p> | <p>The sum of the number of times L0 and L1 appear in an hour equals three. See L0 and L1 for fault handling methods</p> |
| <p>H5</p> | <p>The DC fan failure</p> | <ol style="list-style-type: none"> 1. Strong wind or typhoon below toward to the fan, to make the fan running in the opposite direction. Change the unit direction or make shelter to avoid typhoon below to the fan. 2. fan motor is broken, change a new fan motor. |
| <p>H7</p> | <p>Main circuit voltage failure</p> | <ol style="list-style-type: none"> 1. Whether the power supply input is in the available range. 2. Power off and power on for several times rapidly in short time. Remain the unit power off for more than 3 minutes than power on. 3. the circuit defect part of Main control board is defective. Replace a new Main PCB. |
| <p>H8</p> | <p>Pressure sensor failure</p> | <ol style="list-style-type: none"> 1. Pressure sensor connector is loosen, reconnect it. 2. Pressure sensor failure. change a new sensor. |

| | | |
|------------------|---|---|
| <p><i>HF</i></p> | <p>The main control board PCB B EEPROM failure</p> | <ol style="list-style-type: none"> 1. The EEPROM parameter is error, rewrite the EEPROM data. 2. EEPROM chip part is broken, change a new EEPROM chip part. 3. Main PCB is broken, change a new PCB. |
| <p><i>HH</i></p> | <p>H6 displayed 10 times in 2 hours</p> | <p>Refer to H6</p> |
| <p><i>HP</i></p> | <p>Low pressure protection Pe<0.6) occurred 3 times in an hour</p> | <p>Refer to P0</p> |
| <p><i>P0</i></p> | <p>Low pressure protection</p> | <ol style="list-style-type: none"> 1. System is lack of refrigerant volume. Charge the refrigerant in right volume. 2. When at heating mode or DHW mode, the outdoor heating exchanger is dirty or something is block on the surface. Clean the outdoor heating exchanger or remove the obstruction. 3. The water flow is too low in cooling mode.increase the water flow. 4. Electrical expansion valve locked or winding connector is loosen. Tap-tap the valve body and plug in/ plug off the connector for several times to make sure the valve is working correctly. |
| <p><i>PI</i></p> | <p>High pressure switch protection</p> | <p>Heating mode, DHW mode:</p> <ol style="list-style-type: none"> 1.The water flow is low; water temp is high, whether there is air in the water system. Release the air. 2. Water pressure is lower than 0.1Mpa, charge the water to let the pressure in the range of 0.15~0.2Mpa. 3. Over charge the refrigerant volume. Recharge the refrigerant in right volume. 4. Electrical expansion valve locked or winding connector is loosen. Tap-tap the valve body and plug in/ plug off the connector for several times to make sure the valve is working correctly. And install the winding in the right location DHW mode: Water tank heat exchanger is smaller <p>Cooling mode:</p> <ol style="list-style-type: none"> 1. Heat exchanger cover is not removed. Remove it. 2. Heat exchanger is dirty or something is block on the surface. Clean the heat exchanger or remove the obstruction |

| | | |
|-----------|--|--|
| <p>P3</p> | <p>Compressor overcurrent protection</p> | <ol style="list-style-type: none"> 1. The same reason to P1. 2. Power supply voltage of the unit is low, increase the power voltage to the required range |
| <p>P4</p> | <p>High discharge temperature protection</p> | <ol style="list-style-type: none"> 1. The same reason to P1. 2. TW_out temp.sensor is loosen Reconnect it. 3. T1 temp.sensor is loosen. Reconnect it. 4. T5 temp.sensor is loosen. Reconnect it |
| <p>P9</p> | <p>DC fan motor protect</p> | <p>Contact your local dealer</p> |
| <p>Pd</p> | <p>High temperature protection of refrigerant outlet temp of condenser</p> | <ol style="list-style-type: none"> 1. Heat exchanger cover is not removed. Remove it. 2. Heat exchanger is dirty or something is block on the surface. Clean the heat exchanger or remove the obstruction. 3. There is no enough space around the unit for heat exchanging. 4. Fan motor is broken, replace a new one |
| <p>E7</p> | <p>Transducer module temperature too high protect</p> | <ol style="list-style-type: none"> 1. Power supply voltage of the unit is low, increase the power voltage to the required range. 2. The space between the units is too narrow for heat exchange. Increase the space between the units. 3. Heat exchanger is dirty or something is block on the surface. Clean the heat exchanger or remove the obstruction. 4. Fan is not running. Fan motor or fan is broken, Change a new fan or fan motor. 5. Water flow rate is low, there is air in system, or pump head is not enough. Release the air and reselect the pump. 6. Water outlet temp.sensor is loosen or broken, reconnect it or change a new one. |

| | | |
|---|---|---|
| <p style="text-align: center; font-size: 24px; font-weight: bold;">F1</p> | <p>DC generatrix voltage is too low</p> | <ol style="list-style-type: none"> 1. Check the power supply. 2. If the power supply is OK, and check if LED light is OK, check the voltage PN, if it is 380V, the problem usually comes from the main board. And if the light is OFF, disconnect the power, check the IGBT, check those diodes, if the voltage is not correct, the inverter board is damaged, change it. 3. And if those IGBT are OK, which means the inverter board is OK, power from rectifier bridge is not correct, check the bridge. (Same method as IGBT, disconnect the power, check those diodes are damaged or not). 4. Usually if F1 exist when compressor start, the possible reason is main board. If F1 exist when fan start, it may be because of inverter board |
| <p style="text-align: center; font-size: 24px; font-weight: bold;">bH</p> | <p>PED PCB failure</p> | <ol style="list-style-type: none"> 1. After 5 minutes of power-off interval, power on again and observe whether it can be recovered; 2. If it can't be restored, replace PED safety plate, power on again, and observe whether it can be restored; 3. If it can not be recovered, the IPM module board should be replaced. |

| | ERROR CODE | MALFUNCTION OR PROTECTION | FAILURE CAUSE AND CORRECTIVE ACTION |
|----|------------|--|--|
| P6 | L0 | Module protection | <ol style="list-style-type: none"> 1. Check the Heat pump system pressure; 2. Check the phase resistance of compressor; 3. Check the U、V、W power line connection sequence between the inverter board and the compressor; 4. Check the L1、L2、L3 power line connection between the inverter board and the Filter board ; 5. Check the inverter board. |
| | L1 | DC generatrix low voltage protection | |
| | L2 | DC generatrix high voltage protection | |
| | L4 | MCE malfunction | |
| | L5 | Zero speed protection | |
| | L8 | Speed difference >15Hz protection between the front and the back clock | |
| | L9 | Speed difference >15Hz protection between the real and the setting speed | |

TECHNICAL SPECIFICATIONS

| Model (Capacity mark) | 4 kW | 6 kW | 8 kW | 10 kW |
|---|-----------------------------|-------|--------------|-------|
| Power supply | 220-240V~ 50Hz | | | |
| Rated power input | 2200W | 2600W | 3300W | 3600W |
| Rated current | 10.5A | 12.0A | 14.5A | 16.0A |
| Normal capacity | Refer to the technical data | | | |
| Dimensions (W×H×D)[mm] | 1008*712*426 | | 1118*865*523 | |
| Packing (W×H×D)[mm] | 1065*810*485 | | 1190*970*560 | |
| Fan motor | DC motor / Horizontal | | | |
| Compressor | DC inverter dual rotary | | | |
| Heat exchanger | Fin-coil | | | |
| Refrigerant | | | | |
| Type | R32 | | | |
| Quantity | 1500 g | | 1650g | |
| Weight | | | | |
| Net weight | 60kg | | 78.5kg | |
| Gross weight | 65.5kg | | 92kg | |
| Connections | | | | |
| Gas side | φ15.9 | | φ15.9 | |
| Liquid side | φ6.35 | | φ9.52 | |
| Drain connection | DN32 | | | |
| Max. piping length | 30m | | | |
| Max. difference in height when outdoor unit is upside | 20m | | | |
| Refrigerant to be added | 20g/m | | 38g/m | |
| Operation ambient temperature range | | | | |
| Heating mode | -25~+35°C | | | |
| Cooling mode | -5~+43°C | | | |
| Domestic hot water mode | -25~+43°C | | | |

| Model (Capacity mark) | 12 kW | 14 kW | 16 kW | 12 kW 3-phase | 14 kW 3-phase | 16 kW 3-phase |
|---|-----------------------------|--------|-------|-------------------|---------------|---------------|
| Power supply | 220-240V~ 50Hz | | | 380-415V 3N~ 50Hz | | |
| Rated power input | 5400 W | 5700 W | 6100W | 5400W | 5700W | 6100W |
| Rated current | 14.5A | 25.0A | 26.0A | 9.0A | 10.0A | 11.0A |
| Normalinal capacity | Refer to the technical data | | | | | |
| Dimensions (W×H×D)[mm] | 1118*865*523 | | | 1118*865*523 | | |
| Packing (W×H×D)[mm] | 1190*970*560 | | | 1190*970*560 | | |
| Fan motor | DC motor / Horizontal | | | | | |
| Compressor | DC inverter dual rotary | | | | | |
| Heat exchanger | Fin-coil | | | | | |
| Refrigerant | | | | | | |
| Type | R32 | | | | | |
| Quantity | 1840g | | | 1840g | | |
| Weight | | | | | | |
| Net weight | 100kg | | | 116kg | | |
| Gross weight | 113.5kg | | | 129.5kg | | |
| Connections | | | | | | |
| Gas side | φ15.9 | | | φ15.9 | | |
| Liquid side | φ9.52 | | | φ9.52 | | |
| Drain connection | DN32 | | | | | |
| Max. piping length | 30m | | | | | |
| Max. differance in height when outdoor unit is upside | 20m | | | | | |
| Refrigerant to be added | 38g/m | | | | | |
| Operation ambient temperature range | | | | | | |
| Heating mode | -25~+35°C | | | | | |
| Cooling mode | -5~+43°C | | | | | |
| Domestic hot water mode | -25~+43°C | | | | | |

INFORMATION SERVICING

1) Checks to the area

Prior to beginning work on systems containing flammable refrigerants, safety checks are necessary to ensure that the risk of ignition is minimised. For repair to the refrigerating system, the following precautions shall be complied with prior to conducting work on the system.

2) Work procedure

Works shall be undertaken under a controlled procedure so as to minimise the risk of a flammable gas or vapour being present while the work is being performed.

3) General work area

All maintenance staff and others working in the local area shall be instructed on the nature of work being carried out. Work in confined spaces shall be avoided. The area around the work space shall be sectioned off. Ensure that the conditions within the area have been made safe by control of flammable material.

4) Checking for presence of refrigerant

The area shall be checked with an appropriate refrigerant detector prior to and during work, to ensure the technician is aware of potentially flammable atmospheres. Ensure that the leak detection equipment being used is suitable for use with flammable refrigerants, i.e. no sparking, adequately sealed or intrinsically safe.

5) Presence of fire extinguisher

If any hot work is to be conducted on the refrigeration equipment or any associated parts, appropriate fire extinguishing equipment shall be available to hand. Have a dry power or CO₂ fire extinguisher adjacent to the charging area.

6) No ignition sources

No person carrying out work in relation to a refrigeration system which involves exposing any pipe work that contains or has contained flammable refrigerant shall use any sources of ignition in such a manner that it may lead to the risk of fire or explosion. All possible ignition sources, including cigarette smoking, should be kept sufficiently far away from the site of installation, repairing, removing and disposal, during which flammable refrigerant can possibly be released to the surrounding space. Prior to work taking place, the area around the equipment is to be surveyed to make sure that there are no flammable hazards or ignition risks. NO SMOKING signs shall be displayed.

7) Ventilated area

Ensure that the area is in the open or that it is adequately ventilated before breaking into the system or conducting any hot work. A degree of ventilation shall continue during the period that the work is carried out. The ventilation should safely disperse any released refrigerant and preferably expel it externally into the atmosphere.

8) Checks to the refrigeration equipment

Where electrical components are being changed, they shall be fit for the purpose and to the correct specification. At all times the manufacturer's maintenance and service guidelines shall be followed. If in doubt consult the manufacturer's technical department for assistance. The following checks shall be applied to installations using flammable refrigerants:

The charge size is in accordance with the room size within which the refrigerant containing parts are installed; The ventilation machinery and outlets are operating adequately and are not obstructed;

If an indirect refrigerating circuit is being used, the secondary circuits shall be checked for the presence of refrigerant; marking to the equipment continues to be visible and legible.

Marking and signs that are illegible shall be corrected;

Refrigeration pipe or components are installed in a position where they are unlikely to be exposed to any substance which may corrode refrigerant containing components, unless the components are constructed of materials which are inherently resistant to being corroded or are suitably protected against being so corroded.

9) Checks to electrical devices

Repair and maintenance to electrical components shall include initial safety checks and component inspection procedures. If a fault exists that could compromise safety, then no electrical supply shall be connected to the circuit until it is satisfactorily dealt with. If the fault cannot be corrected immediately but it is necessary to continue operation, an adequate temporary solution shall be used. This shall be reported to the owner of the equipment so all parties are advised.

Initial safety checks shall include:

That capacitors are discharged: this shall be done in a safe manner to avoid possibility of sparking;

That there are no live electrical components and wiring are exposed while charging, recovering or purging the system; That there is continuity of earth bonding.

10) Repairs to sealed components

a) During repairs to sealed components, all electrical supplies shall be disconnected from the equipment being worked upon prior to any removal of sealed covers, etc. If it is absolutely necessary to have an electrical supply to equipment during servicing, then a permanently operating form of leak detection shall be located at the most critical point to warn of a potentially hazardous situation.

b) Particular attention shall be paid to the following to ensure that by working on electrical components, the casing is not altered in such a way that the level of protection is affected. This shall include damage to cables, excessive number of connections, terminals not made to original specification, damage to seals, incorrect fitting of glands, etc.

NOTE

The use of silicon sealant may inhibit the effectiveness of some types of leak detection equipment. Intrinsically safe components do not have to be isolated prior to working on them.

11) Repair to intrinsically safe components

Do not apply any permanent inductive or capacitance loads to the circuit without ensuring that this will not exceed the permissible voltage and current permitted for the equipment in use. Intrinsically safe components are the only types that can be worked on while live in the presence of a flammable atmosphere. The test apparatus shall be at the correct rating. Replace components only with parts specified by the manufacturer. Other parts may result in the ignition of refrigerant in the atmosphere from a leak.

12) Cabling

Check that cabling will not be subject to wear, corrosion, excessive pressure, vibration, sharp edges or any other adverse environmental effects. The check shall also take into account the effects of aging or continual vibration from sources such as compressors or fans.

13) Detection of flammable refrigerants

Under no circumstances shall potential sources of ignition be used in the searching for or detection of refrigerant leaks. A halide torch (or any other detector using a naked flame) shall not be used.

14) Leak detection methods

The following leak detection methods are deemed acceptable for systems containing flammable refrigerants. Electronic leak detectors shall be used to detect flammable refrigerants, but the sensitivity may not be adequate, or may need recalibration. (Detection equipment shall be calibrated in a refrigerant-free area.) Ensure that the detector is not a potential source of ignition and is suitable for the refrigerant. Leak detection equipment shall be set at a percentage of the LFL of the refrigerant and shall be calibrated to the refrigerant employed and the appropriate percentage of gas (25% maximum) is confirmed. Leak detection fluids are suitable for use with most refrigerants but the use of detergents containing chlorine shall be avoided as the chlorine may react with the refrigerant and corrode the copper pipework. If a leak is suspected, all naked flames shall be removed or extinguished. If a leakage of refrigerant is found which requires brazing, all of the refrigerant shall be recovered from the system, or isolated (by means of shut off valves) in a part of the system remote from the leak. Oxygen free nitrogen (OFN) shall then be purged through the system both before and during the brazing process.

15) Removal and evacuation

When breaking into the refrigerant circuit to make repairs or for any other purpose conventional procedures shall be used. However, it is important that best practice is followed since flammability is a consideration. The following procedure shall be adhered to:

- Remove refrigerant;
- Purge the circuit with inert gas; Evacuate;
- Purge again with inert gas;
- Open the circuit by cutting or brazing.

The refrigerant charge shall be recovered into the correct recovery cylinders. The system shall be flushed with OFN to render the unit safe. This process may need to be repeated several times.

Compressed air or oxygen shall not be used for this task.

Flushing shall be achieved by breaking the vacuum in the system with OFN and continuing to fill until the working pressure is achieved, then venting to atmosphere, and finally pulling down to a vacuum. This process shall be repeated until no refrigerant is within the system.

When the final OFN charge is used, the system shall be vented down to atmospheric pressure to enable work to take place. This operation is absolutely vital if brazing operations on the pipe-work are to take place.

Ensure that the outlet for the vacuum pump is not closed to any ignition sources and there is ventilation available.

16) Charging procedures

In addition to conventional charging procedures, the following requirements shall be followed:

- Ensure that contamination of different refrigerants does not occur when using charging equipment. Hoses or lines shall be as short as possible to minimize the amount of refrigerant contained in them
- Ensure that apparatus is mounted securely.
- Ensure that seals or sealing materials have not degraded such that they no longer serve the purpose of preventing the ingress of flammable atmospheres. Replacement parts shall be in accordance with the manufacturer's specifications
- Cylinders shall be kept upright.
- Ensure that the refrigeration system is earthed prior to charging the system with refrigerant. Label the system when charging is complete (if not already).
- Extreme care shall be taken not to overfill the refrigeration system.
- Prior to recharging the system it shall be pressure tested with OFN. The system shall be leak tested on completion of charging but prior to commissioning. A follow up leak test shall be carried out prior to leaving the site.

17) Decommissioning

Before carrying out this procedure, it is essential that the technician is completely familiar with the equipment and all its detail. It is recommended good practice that all refrigerants are recovered safely. Prior to the task being carried out, an oil and refrigerant sample shall be taken.

In case analysis is required prior to re-use of reclaimed refrigerant. It is essential that electrical power is available before the task is commenced.

- a) Become familiar with the equipment and its operation.
- b) Isolate system electrically
- c) Before attempting the procedure ensure that:
 - Mechanical handling equipment is available, if required, for handling refrigerant cylinders; All personal protective equipment is available and being used correctly;
 - The recovery process is supervised at all times by a competent person; Recovery equipment and cylinders conform to the appropriate standards.
- d) Pump down refrigerant system, if possible.
- e) If a vacuum is not possible, make a manifold so that refrigerant can be removed from various parts of the system.
- f) Make sure that cylinder is situated on the scales before recovery takes place.
- g) Start the recovery machine and operate in accordance with manufacturer's instructions.
- h) Do not overfill cylinders. (No more than 80% volume liquid charge).
- i) Do not exceed the maximum working pressure of the cylinder, even temporarily.
- j) When the cylinders have been filled correctly and the process completed, make sure that the cylinders and the equipment are removed from site promptly and all isolation valves on the equipment are closed off.
- k) Recovered refrigerant shall not be charged into another refrigeration system unless it has been cleaned and checked.

18) Labelling

Equipment shall be labelled stating that it has been de-commissioned and emptied of refrigerant. The label shall be dated and signed. Ensure that there are labels on the equipment stating the equipment contains flammable refrigerant.

19) Recovery

When removing refrigerant from a system, either for service or decommissioning, it is recommended good practice that all refrigerants are removed safely.

When transferring refrigerant into cylinders, ensure that only appropriate refrigerant recovery cylinders are employed. Ensure that the correct numbers of cylinders for holding the total system charge are available. All cylinders to be used are designated for the recovered refrigerant and labelled for that refrigerant (i.e. special cylinders for the recovery of refrigerant). Cylinders shall be complete with pressure relief valve and associated shut-off valves in good working order.

Empty recovery cylinders are evacuated and, if possible, cooled before recovery occurs.

The recovery equipment shall be in good working order with a set of instructions concerning the equipment that is at hand and shall be suitable for the recovery of flammable refrigerants. In addition, a set of calibrated weighing scales shall be available and in good working order.

Hoses shall be complete with leak-free disconnect couplings and in good condition. Before using the recovery machine, check that it is in satisfactory working order, has been properly maintained and that any associated electrical components are sealed to prevent ignition in the event of a refrigerant release. Consult manufacturer if in doubt.

The recovered refrigerant shall be returned to the refrigerant supplier in the correct recovery cylinder, and the relevant Waste Transfer Note arranged. Do not mix refrigerants in recovery units and especially not in cylinders.

If compressors or compressor oils are to be removed, ensure that they have been evacuated to an acceptable level to make certain that flammable refrigerant does not remain within the lubricant. The evacuation process shall be carried out prior to retraining the compressor to the suppliers. Only electric heating to the compressor body shall be employed to accelerate this process. When oil is drained from a system, it shall be carried out safely.

20) Transportation, marking and storage for units

Transport of equipment containing flammable refrigerants Compliance with the transport regulations
Marking of equipment using signs Compliance with local regulations

Disposal of equipment using flammable refrigerants Compliance with national regulations
Storage of equipment/appliances

The storage of equipment should be in accordance with the manufacturer's instructions. Storage of packed (unsold) equipment

Storage package protection should be constructed such that mechanical damage to the equipment inside the package will not cause a leak of the refrigerant charge.

The maximum number of pieces of equipment permitted to be stored together will be determined by local regulations.

ANNEX A: Refrigerant cycle

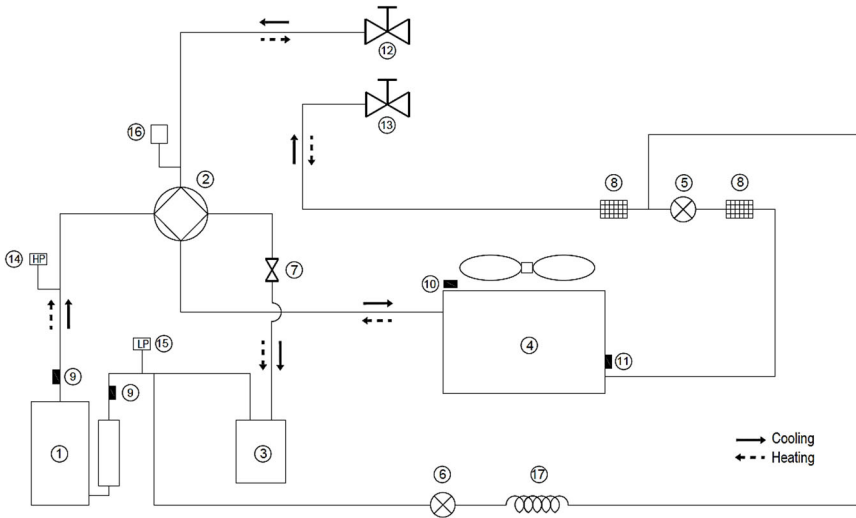

| Item | Description | Item | Description |
|------|----------------------------------|------|----------------------------|
| 1 | Compressor | 10 | Outdoor temperature sensor |
| 2 | 4-Way Valve | 11 | Outdoor exchanger sensor |
| 3 | Gas-liquid separator | 12 | Stop valve (gas) |
| 4 | Air side heat exchanger | 13 | Stop valve (liquid) |
| 5 | Electronic expansion Valve | 14 | High Pressure Switch |
| 6 | Single-way electromagnetic valve | 15 | Low Pressure Switch |
| 7 | Pipe joint | 16 | Pressure valve |
| 8 | Filter | 17 | Capillary |
| 9 | Discharge line sensor | | |

ANNEX B: Electrically controlled wiring diagram 4~10kW

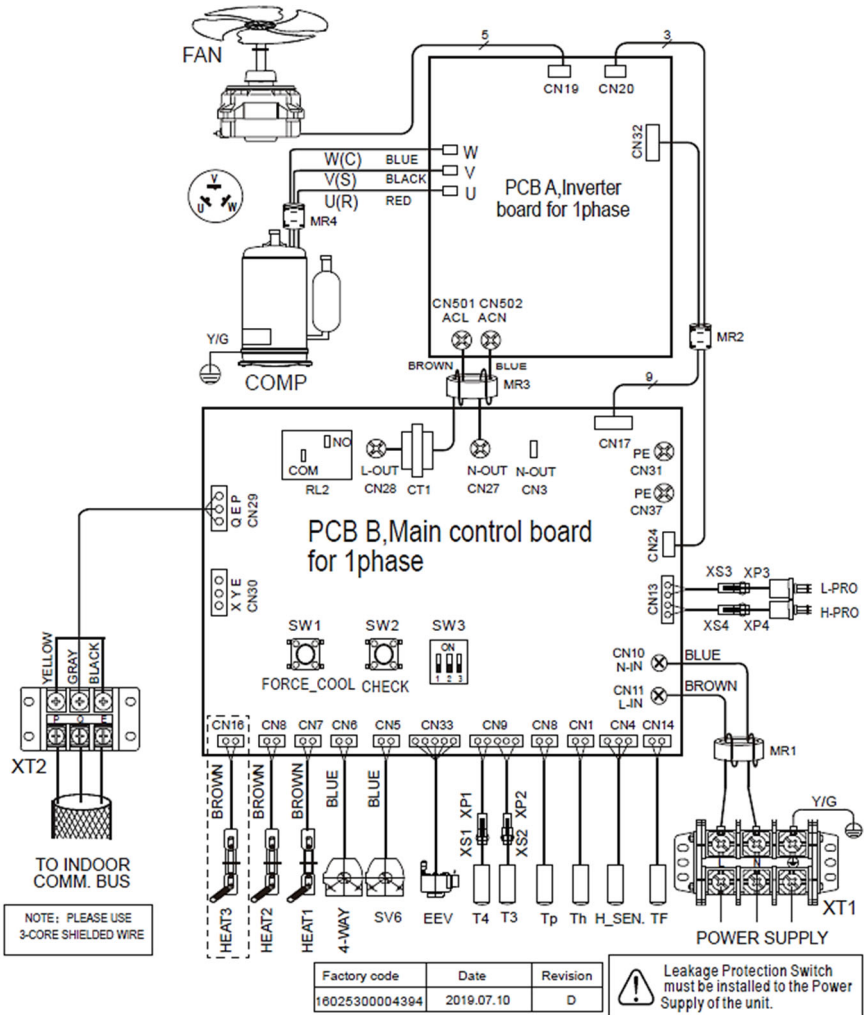

Table1: The environment temperature curve of the low temperature setting for heating

| T4 | ≤ -20 | -19 | -18 | -17 | -16 | -15 | -14 | -13 | -12 | -11 | -10 | -9 | -8 | -7 | -6 | -5 | -4 | -3 | -2 | -1 | 0 |
|-------|-------|-----|-----|-----|-----|-----|-----|-----|-----|-----|-----|----|----|----|----|----|----|----|----|------|----|
| 1-T1S | 38 | 38 | 38 | 38 | 37 | 37 | 37 | 37 | 37 | 37 | 36 | 36 | 36 | 36 | 36 | 36 | 36 | 35 | 35 | 35 | 35 |
| 2-T1S | 35 | 35 | 35 | 35 | 34 | 34 | 34 | 34 | 34 | 34 | 34 | 34 | 33 | 33 | 33 | 33 | 33 | 33 | 33 | 33 | 32 |
| 3-T1S | 33 | 33 | 33 | 33 | 33 | 33 | 33 | 32 | 32 | 32 | 32 | 32 | 32 | 32 | 32 | 32 | 32 | 32 | 32 | 32 | 31 |
| 4-T1S | 35 | 35 | 35 | 34 | 34 | 34 | 34 | 34 | 34 | 33 | 33 | 33 | 33 | 33 | 33 | 32 | 32 | 32 | 32 | 32 | 31 |
| 5-T1S | 33 | 33 | 33 | 33 | 32 | 32 | 32 | 32 | 32 | 32 | 32 | 32 | 31 | 31 | 31 | 31 | 31 | 31 | 31 | 31 | 30 |
| 6-T1S | 31 | 31 | 31 | 31 | 30 | 30 | 30 | 30 | 30 | 30 | 30 | 30 | 29 | 29 | 29 | 29 | 29 | 29 | 29 | 29 | 28 |
| 7-T1S | 29 | 29 | 29 | 29 | 29 | 29 | 29 | 28 | 28 | 28 | 28 | 28 | 28 | 28 | 28 | 28 | 28 | 28 | 28 | 28 | 27 |
| 8-T1S | 29 | 29 | 29 | 29 | 28 | 28 | 28 | 28 | 28 | 28 | 28 | 28 | 27 | 27 | 27 | 27 | 27 | 27 | 27 | 27 | 26 |
| T4 | 1 | 2 | 3 | 4 | 5 | 6 | 7 | 8 | 9 | 10 | 11 | 12 | 13 | 14 | 15 | 16 | 17 | 18 | 19 | ≥ 20 | |
| 1-T1S | 35 | 35 | 35 | 35 | 34 | 34 | 34 | 34 | 34 | 33 | 33 | 33 | 33 | 33 | 33 | 33 | 32 | 32 | 32 | 32 | 32 |
| 2-T1S | 32 | 32 | 32 | 32 | 32 | 32 | 32 | 31 | 31 | 31 | 31 | 31 | 31 | 31 | 31 | 30 | 30 | 30 | 30 | 30 | 30 |
| 3-T1S | 31 | 31 | 31 | 31 | 31 | 31 | 31 | 31 | 31 | 31 | 31 | 31 | 31 | 30 | 30 | 30 | 30 | 30 | 30 | 30 | 30 |
| 4-T1S | 31 | 31 | 31 | 31 | 31 | 30 | 30 | 30 | 30 | 30 | 30 | 29 | 29 | 29 | 29 | 29 | 29 | 28 | 28 | 28 | 28 |
| 5-T1S | 30 | 30 | 30 | 30 | 30 | 30 | 30 | 29 | 29 | 29 | 29 | 29 | 29 | 29 | 29 | 29 | 29 | 28 | 28 | 28 | 28 |
| 6-T1S | 28 | 28 | 28 | 28 | 28 | 28 | 28 | 27 | 27 | 27 | 27 | 27 | 27 | 27 | 27 | 26 | 26 | 26 | 26 | 26 | 26 |
| 7-T1S | 27 | 27 | 27 | 27 | 27 | 27 | 27 | 27 | 27 | 27 | 27 | 27 | 27 | 26 | 26 | 26 | 26 | 26 | 26 | 26 | 26 |
| 8-T1S | 26 | 26 | 26 | 26 | 26 | 26 | 26 | 25 | 25 | 25 | 25 | 25 | 25 | 25 | 25 | 24 | 24 | 24 | 24 | 24 | 24 |

Table2 The environment temperature curve of the high temperature setting for heating

| T4 | ≤ -20 | -19 | -18 | -17 | -16 | -15 | -14 | -13 | -12 | -11 | -10 | -9 | -8 | -7 | -6 | -5 | -4 | -3 | -2 | -1 | 0 |
|-------|-------|-----|-----|-----|-----|-----|-----|-----|-----|-----|-----|----|----|----|----|----|----|----|----|------|----|
| 1-T1S | 55 | 55 | 55 | 55 | 54 | 54 | 54 | 54 | 54 | 54 | 54 | 54 | 53 | 53 | 53 | 53 | 53 | 53 | 53 | 53 | 52 |
| 2-T1S | 55 | 55 | 54 | 54 | 54 | 54 | 53 | 53 | 53 | 53 | 52 | 52 | 52 | 52 | 51 | 51 | 51 | 51 | 50 | 50 | 50 |
| 3-T1S | 55 | 54 | 54 | 53 | 53 | 53 | 52 | 52 | 52 | 51 | 51 | 50 | 50 | 50 | 49 | 49 | 49 | 49 | 48 | 48 | 47 |
| 4-T1S | 50 | 50 | 50 | 50 | 49 | 49 | 49 | 49 | 49 | 49 | 49 | 49 | 48 | 48 | 48 | 48 | 48 | 48 | 48 | 48 | 47 |
| 5-T1S | 50 | 50 | 49 | 49 | 49 | 49 | 48 | 48 | 48 | 48 | 47 | 47 | 47 | 47 | 46 | 46 | 46 | 46 | 45 | 45 | 45 |
| 6-T1S | 45 | 45 | 45 | 45 | 44 | 44 | 44 | 44 | 44 | 44 | 44 | 44 | 43 | 43 | 43 | 43 | 43 | 43 | 43 | 43 | 42 |
| 7-T1S | 45 | 45 | 44 | 44 | 44 | 44 | 43 | 43 | 43 | 43 | 42 | 42 | 42 | 42 | 41 | 41 | 41 | 41 | 41 | 40 | 40 |
| 8-T1S | 40 | 40 | 40 | 40 | 39 | 39 | 39 | 39 | 39 | 39 | 39 | 39 | 38 | 38 | 38 | 38 | 38 | 38 | 38 | 38 | 37 |
| T4 | 1 | 2 | 3 | 4 | 5 | 6 | 7 | 8 | 9 | 10 | 11 | 12 | 13 | 14 | 15 | 16 | 17 | 18 | 19 | ≥ 20 | |
| 1-T1S | 52 | 52 | 52 | 52 | 52 | 52 | 52 | 51 | 51 | 51 | 51 | 51 | 51 | 51 | 51 | 50 | 50 | 50 | 50 | 50 | 50 |
| 2-T1S | 50 | 49 | 49 | 49 | 49 | 48 | 48 | 48 | 48 | 47 | 47 | 47 | 47 | 46 | 46 | 46 | 46 | 45 | 45 | 45 | 45 |
| 3-T1S | 47 | 46 | 46 | 46 | 45 | 45 | 45 | 44 | 44 | 44 | 43 | 43 | 43 | 42 | 42 | 41 | 41 | 41 | 41 | 40 | 40 |
| 4-T1S | 47 | 47 | 47 | 47 | 47 | 47 | 46 | 46 | 46 | 46 | 46 | 46 | 46 | 46 | 46 | 45 | 45 | 45 | 45 | 45 | 45 |
| 5-T1S | 45 | 44 | 44 | 44 | 44 | 43 | 43 | 43 | 43 | 42 | 42 | 42 | 42 | 41 | 41 | 41 | 41 | 40 | 40 | 40 | 40 |
| 6-T1S | 42 | 42 | 42 | 42 | 42 | 42 | 42 | 41 | 41 | 41 | 41 | 41 | 41 | 41 | 41 | 40 | 40 | 40 | 40 | 40 | 40 |
| 7-T1S | 40 | 39 | 39 | 39 | 39 | 38 | 38 | 38 | 38 | 37 | 37 | 37 | 37 | 36 | 36 | 36 | 36 | 35 | 35 | 35 | 35 |
| 8-T1S | 37 | 37 | 37 | 37 | 37 | 37 | 37 | 36 | 36 | 36 | 36 | 36 | 36 | 36 | 36 | 35 | 35 | 35 | 35 | 35 | 35 |

The automatic setting curve

The automatic setting curve is the ninth curve, this is the calculation:

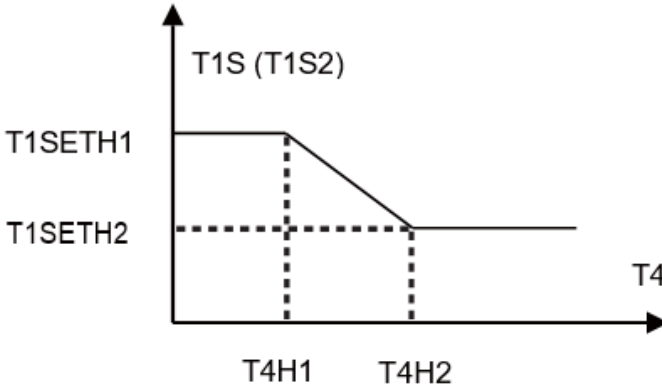

State: In the setting the wired controller, if $T4H2 < T4H1$, then exchange their value; if $T1SETH1 < T1SETH2$, then exchange their value.

Table3 The environment temperature curve of the low temperature setting for cooling

| T4 | $-10 \leq T4 < 15$ | $15 \leq T4 < 22$ | $22 \leq T4 < 30$ | $30 \leq T4 < 46$ |
|---------|--------------------|-------------------|-------------------|-------------------|
| 1 - T1S | 18 | 11 | 8 | 5 |
| T4 | $-10 \leq T4 < 15$ | $15 \leq T4 < 22$ | $22 \leq T4 < 30$ | $30 \leq T4 < 46$ |
| 2 - T1S | 17 | 12 | 9 | 6 |
| T4 | $-10 \leq T4 < 15$ | $15 \leq T4 < 22$ | $22 \leq T4 < 30$ | $30 \leq T4 < 46$ |
| 3 - T1S | 18 | 13 | 10 | 7 |
| T4 | $-10 \leq T4 < 15$ | $15 \leq T4 < 22$ | $22 \leq T4 < 30$ | $30 \leq T4 < 46$ |
| 4 - T1S | 19 | 14 | 11 | 8 |
| T4 | $-10 \leq T4 < 15$ | $15 \leq T4 < 22$ | $22 \leq T4 < 30$ | $30 \leq T4 < 46$ |
| 5 - T1S | 20 | 15 | 12 | 9 |
| T4 | $-10 \leq T4 < 15$ | $15 \leq T4 < 22$ | $22 \leq T4 < 30$ | $30 \leq T4 < 46$ |
| 6 - T1S | 21 | 16 | 13 | 10 |
| T4 | $-10 \leq T4 < 15$ | $15 \leq T4 < 22$ | $22 \leq T4 < 30$ | $30 \leq T4 < 46$ |
| 7 - T1S | 22 | 17 | 14 | 11 |
| T4 | $-10 \leq T4 < 15$ | $15 \leq T4 < 22$ | $22 \leq T4 < 30$ | $30 \leq T4 < 46$ |
| 8 - T1S | 23 | 18 | 15 | 12 |

Table4 The environment temperature curve of the high temperature setting for cooling

| T4 | -10 ≤ T4 < 15 | 15 ≤ T4 < 22 | 22 ≤ T4 < 30 | 30 ≤ T4 < 46 |
|---------|---------------|--------------|--------------|--------------|
| 1 - T1S | 22 | 20 | 18 | 16 |
| T4 | -10 ≤ T4 < 15 | 15 ≤ T4 < 22 | 22 ≤ T4 < 30 | 30 ≤ T4 < 46 |
| 2 - T1S | 20 | 19 | 18 | 17 |
| T4 | -10 ≤ T4 < 15 | 15 ≤ T4 < 22 | 22 ≤ T4 < 30 | 30 ≤ T4 < 46 |
| 3 - T1S | 23 | 21 | 19 | 17 |
| T4 | -10 ≤ T4 < 15 | 15 ≤ T4 < 22 | 22 ≤ T4 < 30 | 30 ≤ T4 < 46 |
| 4 - T1S | 21 | 20 | 19 | 18 |
| T4 | -10 ≤ T4 < 15 | 15 ≤ T4 < 22 | 22 ≤ T4 < 30 | 30 ≤ T4 < 46 |
| 5 - T1S | 24 | 22 | 20 | 18 |
| T4 | -10 ≤ T4 < 15 | 15 ≤ T4 < 22 | 22 ≤ T4 < 30 | 30 ≤ T4 < 46 |
| 6 - T1S | 22 | 21 | 20 | 19 |
| T4 | -10 ≤ T4 < 15 | 15 ≤ T4 < 22 | 22 ≤ T4 < 30 | 30 ≤ T4 < 46 |
| 7 - T1S | 25 | 23 | 21 | 19 |
| T4 | -10 ≤ T4 < 15 | 15 ≤ T4 < 22 | 22 ≤ T4 < 30 | 30 ≤ T4 < 46 |
| 8 - T1S | 23 | 22 | 21 | 20 |

The automatic setting curve

The automatic setting curve is the ninth curve, this is the calculation

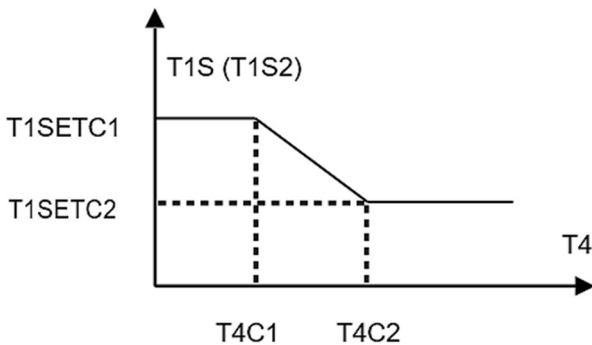

State: In the setting the wired controller, if $T4C2 < T4C1$, then exchange their value; if $T1SETC1 < T1SETC2$, then exchange their value.

CONTENTS

| | |
|--|----|
| GENERAL SAFETY PRECAUTIONS | 3 |
| About the documentation | 3 |
| For the user | 3 |
| A GLANCE OF THE USER INTERFACE | 4 |
| The appearance of the wired controller | 4 |
| Status icons | 4 |
| USING HOME PAGES | 5 |
| MAIN STRUCTURE | 8 |
| About the menu structure | 8 |
| To go to the menu structure | 8 |
| To navigate in the menu structure | 8 |
| BASIC USAGE | 8 |
| Screen Unlock | 9 |
| Turning ON/OFF controls | 9 |
| Adjusting the temperature | 12 |
| Adjusting space operation mode | 12 |
| OPERATION | 13 |
| Operation Mode | 13 |
| Preset Temperature | 14 |
| Domestic Hot Water (DHW) | 17 |
| Schedule | 19 |
| Options | 22 |
| Child Lock | 21 |
| Service Information | 26 |
| Operation Parameter | 27 |
| For Serviceman | 28 |
| Network Configuration Guidelines | 29 |
| MENU STRUCTURE: OVERVIEW | 32 |
| DISPOSAL GUIDELINES | 37 |
| EU DECLARATION OF CONFORMITY | 37 |

Note: All the pictures in this manual are just schematic diagrams, the actual is the standard

GENERAL SAFETY PRECAUTIONS

About the documentation.

DANGER

Indicates a situation that results in death or serious injury.

WARNING

Indicates a situation that could result in death or serious injury.

DANGER RISK OF ELECTROCUTION

Indicates a situation that results in death or serious injury.

DANGER: RISK OF BURNING

Indicates a situation that could result in burning because of extreme hot or cold temperatures.

CAUTION

Indicates a situation that could result in minor or moderate injury.

NOTE

Indicates a situation that could result in death or serious injury.

CAUTION

Indicates a situation that could result in minor or moderate injury.

NOTE

Indicates a situation that could result in equipment or property damage.

CAUTION

DO NOT rinse the unit. This may cause electric shocks or fire.

INFORMATION

Indicates useful tips or additional information.

For the user

If you are not sure how to operate the unit, contact your installer.

The appliance is not intended for use by persons, including children, with reduced physical, sensory or mental capabilities, or lack of experience and knowledge, unless they have been given supervision or instruction concerning use of the appliance by a person responsible for their safety.

Children must be supervised to ensure that they do not play with the product.

A GLANCE OF THE USER INTERFACE

The appearance of the wired controller

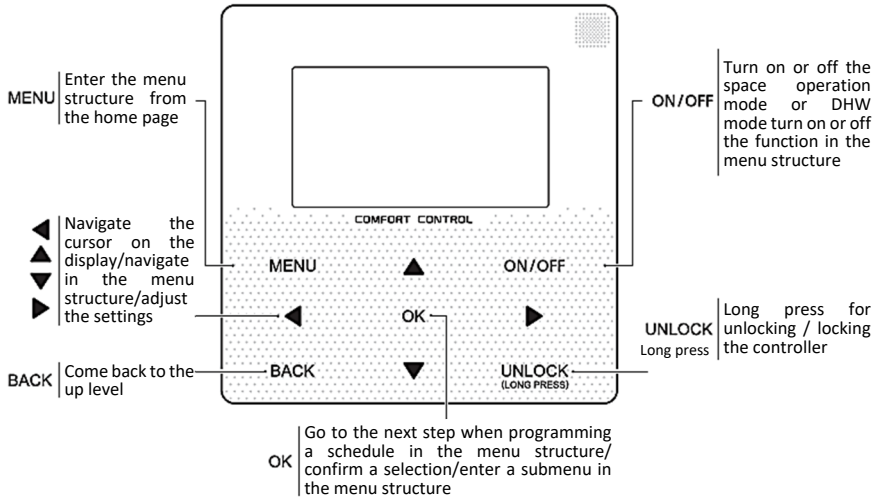

Status icons

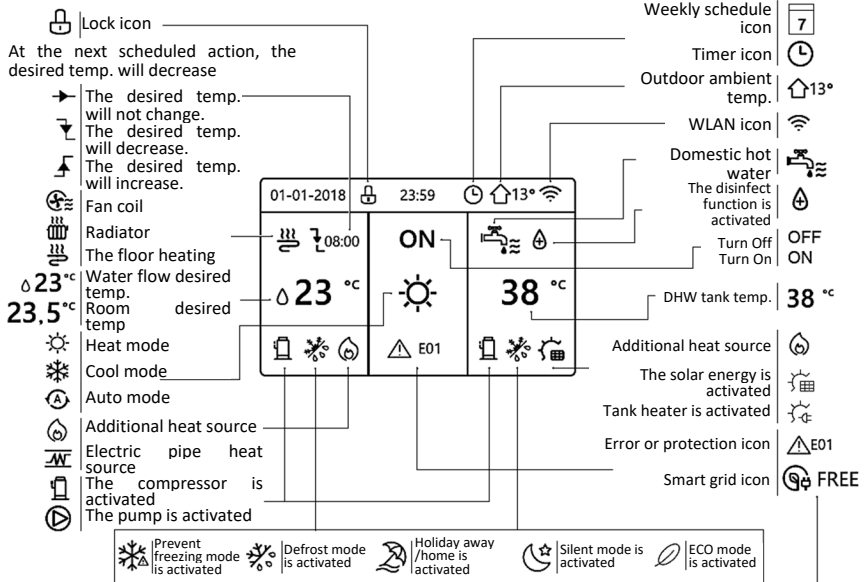

| | Fan coil | Radiator | The floor heating | Domestic hot water |
|-----|----------|----------|-------------------|--------------------|
| ON | | | | |
| OFF | | | | |

| | Free electricity | Valley electricity | Peak electricity |
|------------|------------------|--------------------|------------------|
| Smart grid | FREE | VALLEY | PEAK |

USING HOME PAGES

When you turn on the wired controller, the system will enter the language selection page, You can choose your preferred language, then press **OK** to enter the home pages. If you don't press **OK** in 60 seconds, the system will enter in the currently selected language.

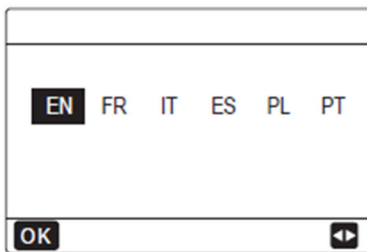

You can use the home pages to read out and change settings that are meant for daily usage. What you can see and do on the home pages is described where applicable. Depending on the system layout, the following home pages may be possible:

- Room desired temperature (ROOM)
- Water flow desired temperature (MAIN)
- DHW tank actual temperature (TANK) DHW=domestic hot water.

Home Page 1

If the WATER FLOW TEMP. is set YES and ROOM TEMP. is set NON. (See "**FOR SERVICEMAN**" > "**TEMP. TYPE SETTING**" in "**Installation and owner's manual (M-thermal split indoor unit)**").

The system has the function including floor heating and domestic water, home page 1 will appear.

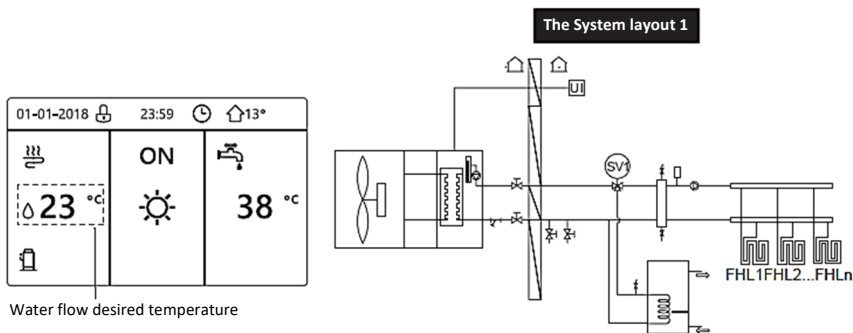

NOTE

All the pictures in the manual are used to explain, the actual pages in the screen may have some difference.

Home Page 2

If the WATER FLOW TEMP. is set NON and ROOM TEMP. is set YES (See "FOR SERVICEMAN" > "TEMP. TYPE SETTING" on "Installation and owner's manual (M-thermal split indoor unit)").

The system has the function including floor heating and domestic hot water, home page 2 will appear:

The System layout 2

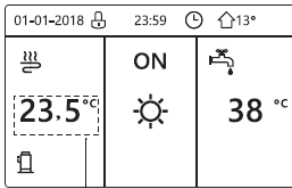

Room desired temperature

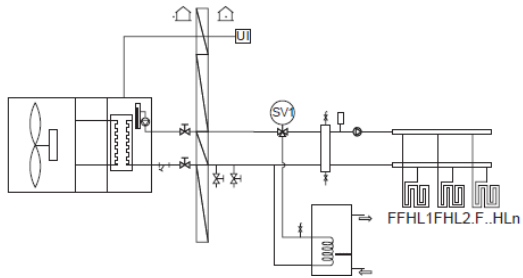

NOTE

The wired controller should be installed in the floor heating room to check the room temperature.

Home Page 3

If the DHW MODE is set NON (See "FOR SERVICEMAN" > "DHW MODE SETTING " in "Installation and owner's manual (M-thermal split indoor unit)"), and if "WATER FLOW TEMP." is set YES, "ROOM TEMP." is set YES, (See "FOR SERVICEMAN" > "TEMP. TYPE SETTING " in "Installation and owner's manual (M-thermal split indoor unit)").

There will be main page and additional page. The system has the function including floor heating and space heating for fan coil, home page 3 will appear:

Main page

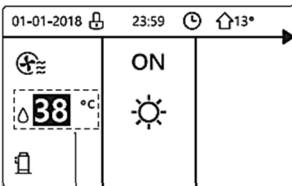

Zone 1 water flow desired temperature



Additional page

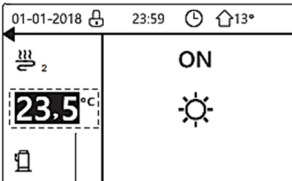

Zone 2 room desired temperature

The System layout 3

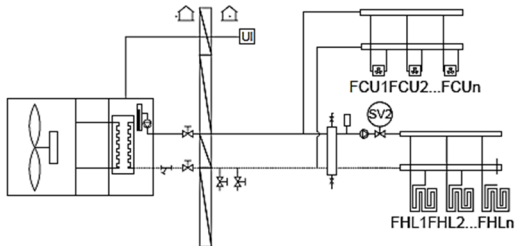

Home Page 4

If the ROOM THERMOSTAT is set DOUBLE ZONE or DOUBLE ZONE is set YES. There will be main page and addition page. The system has the function including floor cooling, space cooling for fan coil and domestic hot water, home page 4 will appear:

Main page

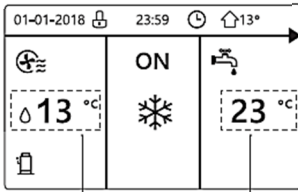

Zone 1 water flow desired temperature DHW tank real temp.

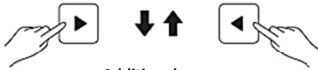

Additional page

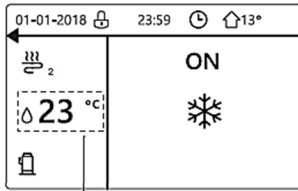

Zone 2 water flow desired temperature

The System layout 4

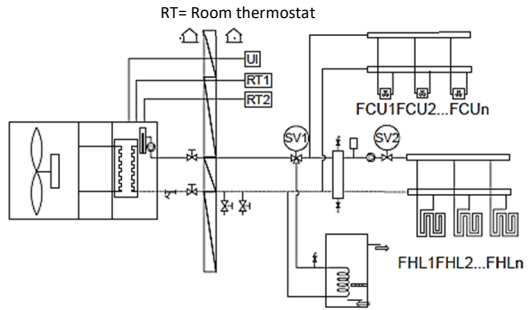

MENU STRUCTURE

About the menu structure

You can use the menu structure to read out and configure settings that are NOT meant for daily usage. What you can see and do in the menu structure is described where applicable. For an overview of the menu structure, see " 7 Menu structure: Overview"

To go to the menu structure

From a home page, press "MENU".
Result: The menu structure appear

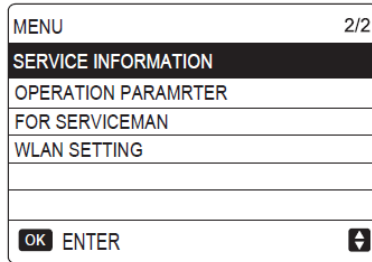
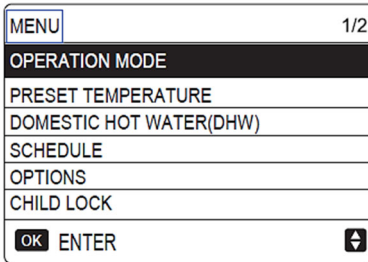

To go to the menu structure



Use "▼", "▲" to scroll.

BASIC USAGE

Screen Unlock

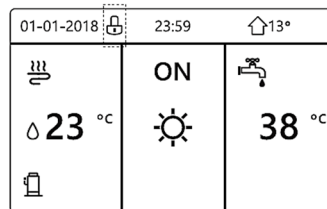
If the icon  is on the screen, the controller is locked.
The following page is displayed:



Press any key, the icon  will flash.
Long press the "UNLOCK" key. The icon  will disappear, the interface can be controlled.

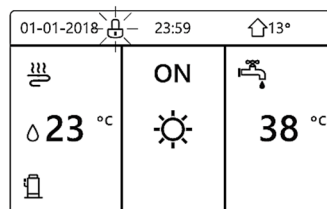

The interface will be locked if there is no handing for a long time(about 120 seconds:it can be set by the interface, see "SERVICE INFORMATION".)

If the interface is unlocked, long press "unlock", the interface will be locked.

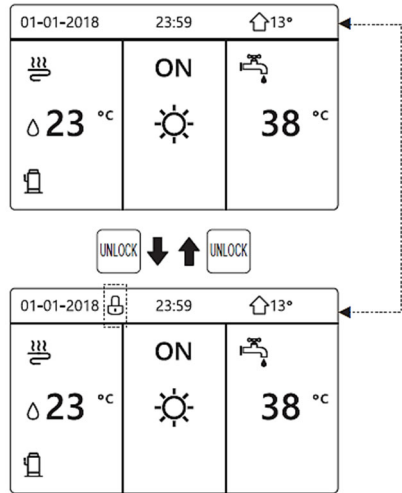

Turning ON/OFF controls

Use the interface to turn on or off the unit for space heating or cooling.

The **ON/OFF** of the unit can be controlled by the interface if the ROOM THERMOSTAT is **NON**. (see "ROOM THERMOSTAT SETTING" in "Installation and owner's manual (M-thermal split indoor unit)")

Press "◀", "▲" on home page, the black cursor will appear:

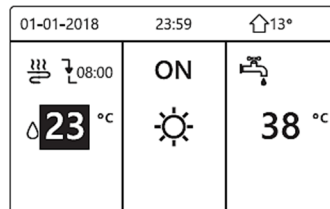

- 1) When the cursor is on the temperature of space operation mode side (Including heat mode ☀, cool mode ❄ and auto mode ⌚ A), press "ON/OFF" key to Turn On/Off space heating or cooling.

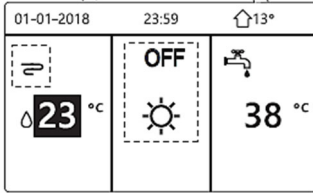
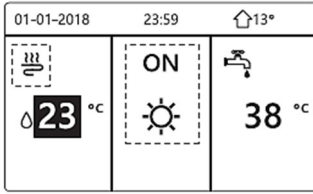

If the DHW TYPE is set NON, then following pages will display:

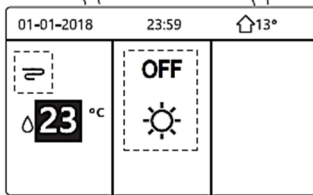
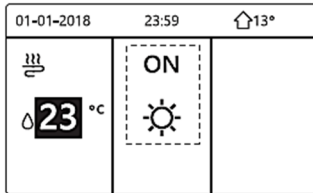

If the TEMP. TYPE is set ROOM TEMP., then following pages will display:

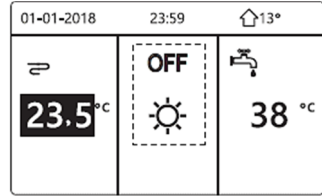
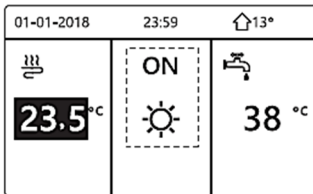

Use the room thermostat to turn on or off the unit for space heating or cooling.

① The room thermostat is not **SET NON** (see "**ROOM THERMOSTAT SETTING**" in "**Installation and owner's manual (M-thermal split indoor unit)**").

The unit for space heating or cooling is turned on or off by the room thermostat, press ON/OFF on the interface, the following page will display:

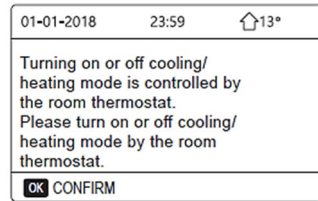

② The room thermostat is **SET DOUBLE ZONE** (see "**ROOM THERMOSTAT SETTING**" in "**Installation and owner's manual (M-thermal split indoor unit)**"). The room thermostat for fan coil is turned off, the room thermostat for the floor heating is turned on, and the unit is running, but the display is OFF. The following page is displayed:

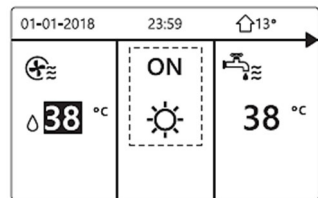

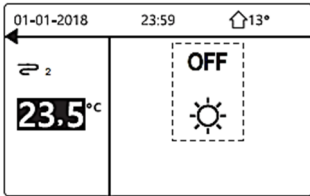
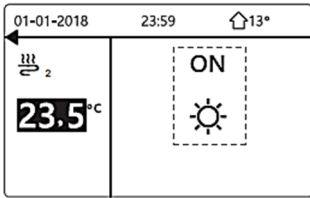
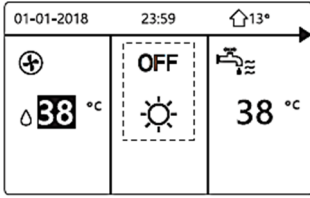

Use the interface to turn on or off the unit for DHW.

Press "▶", "▼" on home page, the black cursor will appear:

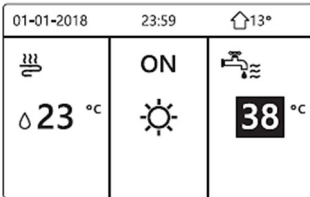

- 2) When the cursor is on the temperature of DHW mode. Press "ON/OFF" key to turn on/off the DHW mode.

If the space operation mode is ON, then following pages will display:

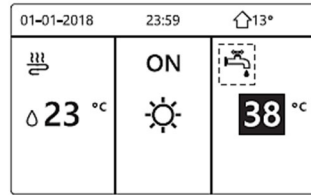
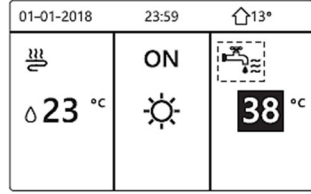

If the space operation mode is OFF, then following pages will display:

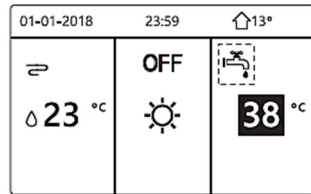
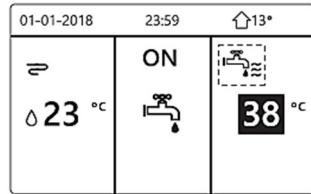

Adjusting the temperature

Press "◀", "▲" on home page, the black cursor will appear:

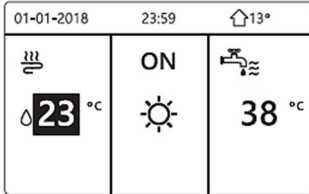

If the cursor is on the temperature, use the "◀", "▶" to select and use "▼", "▲" to adjust the temperature.:

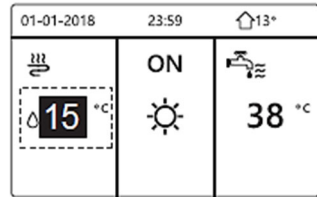
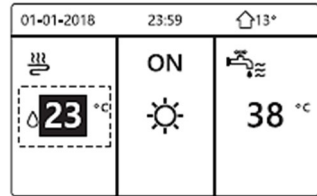
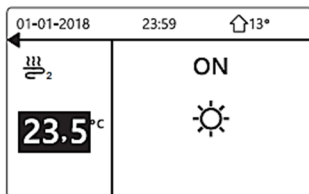
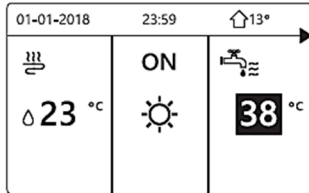
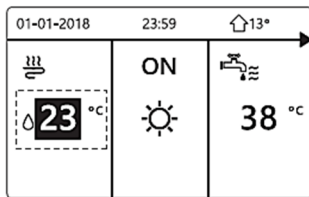

Adjusting space operation mode

Adjusting space operation mode by interface
Go to "MENU" > "OPERATION MODE" .
Press "OK", the following page will appear:

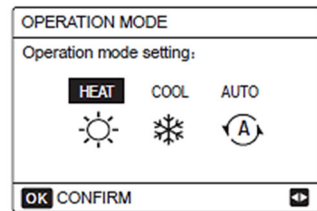

There are three modes to be selected including **HEAT**, **COOL** and **AUTO** mode. Use the "◀", "▶" to scroll, press "OK" to select.

Even you don't press OK button and exit the page by pressing **BACK** button, the mode would still be effective if the cursor had been moved to the operation mode.

If there is only **HEAT (COOL)** mode, the following page will appear:

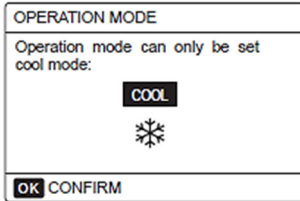
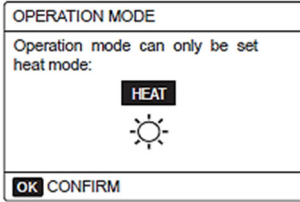

The operation mode can not be changed

| Select | Then the space operation mode is... |
|----------|--|
| HEAT | Always heating mode |
| COOL | Always cooling mode |
| AUTO | Automatically changed by the software based on the outdoor temperature (and depending on installer settings of the indoor temperature), and takes monthly restrictions into account. Note: Automatic changeover is only possible under certain conditions. See the "FOR SERVICEMAN"> "AUTO MODE SETTING" in "Installation and owner's manual (M-thermal split indoor unit)". |

Adjust space operation mode by the room thermostat, see "ROOM THERMOSTAT" on "Installation and owner's manual (M-thermal split indoor unit)".

Go to "MENU">"OPERATION MODE", if you press any key to select or adjust, the page will appear:

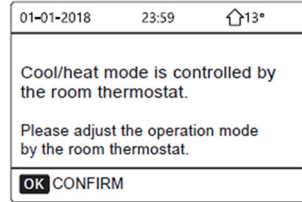

OPERATION

Operation Mode

See "Adjusting space operation mode":

Preset Temperature

PRESET TEMPERATUER has PRESET TEMP.\ WEATHER TEMP. SET\ECO MODE 3 items.

PRESET TEMP.

PRESET TEMP. function is used to set different temperature on different time when the heat mode or cool mode is on.

- PRESET TEMP. = PRESET TEMPERATRE
- The PRESET TEMP. function will be off in these conditions.
 - 1) AUTO mode is running.
 - 2) TIMER or WEEKLY SCHEDULE is running.
- Go to "MENU" > "PRESET TEMPERATURE" >"PRESET TEMP". Press "OK".

The following page will appear:

| PRESET TEMPERATURE | | | 1/2 |
|--------------------|--------------------------|----------|------|
| PRESET TEMP. | WEATHER TEMPSET | ECO MODE | |
| NO. | TIME | TEMP. | |
| 1 | <input type="checkbox"/> | 00:00 | 25°C |
| 2 | <input type="checkbox"/> | 00:00 | 25°C |
| 3 | <input type="checkbox"/> | 00:00 | 25°C |

| PRESET TEMPERATURE | | | 2/2 |
|--------------------|--------------------------|----------|------|
| PRESET TEMP. | WEATHER TEMP.SET | ECO MODE | |
| NO. | TIME | TEMP. | |
| 4 | <input type="checkbox"/> | 00:00 | 25°C |
| 5 | <input type="checkbox"/> | 00:00 | 25°C |
| 6 | <input type="checkbox"/> | 00:00 | 25°C |

When double zone is activated, The **PRESET TEMP.** function only works for zone 1.

use "◀", "▶", "▼", "▲" to scroll and use "▼", "▲" to adjust the time and the temperature.

When the cursor is on "■", as the following page:

| PRESET TEMPERATURE | | | 1/2 |
|--------------------|-------------------------------------|----------|------|
| PRESET TEMP. | WEATHER TEMP.SET | ECO MODE | |
| NO. | TIME | TEMP. | |
| 1 | <input checked="" type="checkbox"/> | 00:00 | 25°C |
| 2 | <input type="checkbox"/> | 00:00 | 25°C |
| 3 | <input type="checkbox"/> | 00:00 | 25°C |

OK SELECT

You press "OK", and the "■" becomes "☑". The timer 1 is selected.

You press "OK" again, and the "☑" becomes "■". The timer 1 is unselected.

| PRESET TEMPERATURE | | | 1/2 |
|--------------------|-------------------------------------|----------|------|
| PRESET TEMP. | WEATHER TEMP.SET | ECO MODE | |
| NO. | TIME | TEMP. | |
| 1 | <input checked="" type="checkbox"/> | 08:00 | 35°C |
| 2 | <input checked="" type="checkbox"/> | 12:00 | 25°C |
| 3 | <input checked="" type="checkbox"/> | 15:00 | 35°C |

OK CANCEL

Use "◀", "▶", "▼", "▲" to scroll and use "▼", "▲" to adjust the time and the temperature.

Six periods and six temperatures can be set.

For example:

Now time is 8:00 and temperature is 30°C. We set the **PRESET TEMP** as following table. The following page will appear:

| | | |
|-------------|------|-------|
| 01-01-2018 | 8:00 | 🏠 13° |
| ☁️ ⬆️ 08:00 | ON | |
| 💧 25 °C | ☀️ | |
| 🗑️ | | |

| NO. | TIME | TEMPER |
|-----|-------|--------|
| 1 | 8:00 | 35°C |
| 2 | 12:00 | 25°C |
| 3 | 15:00 | 35°C |
| 4 | 18:00 | 25°C |
| 5 | 20:00 | 35°C |
| 6 | 23:00 | 25°C |

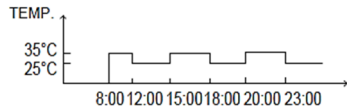

i INFORMATION

When the space operation mode is changed, the **PRESET TEMP.** is off automatically.

The **PRESET TEMP.** function can be used in the heat mode or cool mode. But if the operation mode is changed, the **PRESET TEMP.** function needs to be reset again.

The running preset temperature is invalid when the unit is OFF. It will run according to the next preset temperature when the unit turn on again.

Water Temperature Set

WEATHER TEMP. SET = WEATHER TEMPERATURE SET

WEATHER TEMP.SET function is used to preset the desired water flow temperature depending on the outside air temperature. During the warmer weather the heating is reduced. To save energy, the weather temp.set can decrease the desired water flow temperature when the outdoor air temperature increased in heating mode.

Go to "MENU" > "PRESET TEMPERATURE" > "WEATHER TEMP. SET". Press "OK".

The following page will appear:

| PRESET TEMPERATURE | | |
|------------------------|------------------|----------|
| PRESET TEMP. | WEATHER TEMP SET | ECO MODE |
| ZONE1 C-MODE LOW TEMP. | | OFF |
| ZONE1 H-MODE LOW TEMP. | | OFF |
| ZONE2 C-MODE LOW TEMP. | | OFF |
| ZONE2 H-MODE LOW TEMP. | | OFF |
| ON/OFF ON/OFF | | |

i INFORMATION

WEATHER TEMP. SET have four kinds of curves:

1. the curve of the high temperature setting for heating,
2. the curve of the low temperature setting for heating,
3. the curve of the high temperature setting for cooling.
4. the curve of the low temperature setting for cooling. It only have the curve of the high temperature setting for heating, if the high temperature is set for heating.

It only have the curve of the low temperature setting for heating, if the low temperature is set for heating.

It only have the curve of the high temperature setting for cooling, if the high temperature is set for cooling

It only have the curve of the low temperature setting for cooling, if the low temperature is set for cooling.

See "FOR SERVICEMAN"> "COOL MODE SETTING" and > "HEAT MODE SETTING" in "Installation and owner's manual (M-thermal split indoor unit)".

The desired temperature (T1S) can't be adjusted, when the temperature curve is set ON.

If you want to use heat mode in zone 1, you select "ZONE1 H-MODE LOW TEMP". If you want to use cool mode in zone 1, you select "ZONE1 C-MODE LOW TEMP". If you select "ON", the following page will appear:

| WEATHER TEMP. SET | |
|-------------------------|-----------------|
| WEATHER TEMP. SET TYPE: | |
| 1 | 2 3 4 5 6 7 8 9 |
| OK CONFIRM | |

Use '◀', '▶' to scroll .
Press "OK" to select.

| PRESET TEMPERATURE | | |
|------------------------|------------------|----------|
| PRESET TEMP. | WEATHER TEMP SET | ECO MODE |
| ZONE1 C-MODE LOW TEMP. | | ON |
| ZONE1 H-MODE LOW TEMP. | | OFF |
| ZONE2 C-MODE LOW TEMP. | | OFF |
| ZONE2 H-MODE LOW TEMP. | | OFF |
| ON/OFF ON/OFF | | |

If the weather **TEMP.SET** is activated,the desired temperature can not be adjusted on the interface.Press the "▼", "▲" to adjust the temperature on home page.

The following page will appear:

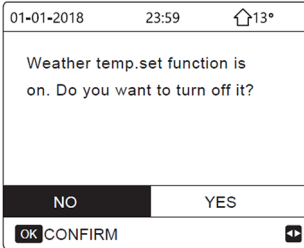

Move to "NO",press "OK" to come back to home page,move to "YES", press "OK" to reset the **WEATHER TEMP. SET**.

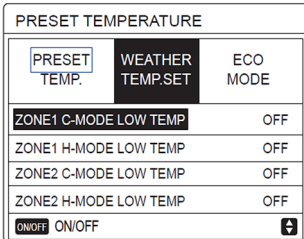

ECO Mode

ECO MODE is used to save energy. Go to "MENU" > "PRESET TEMPERATURE" > "ECO MODE".

Press "OK". The following page will appear:

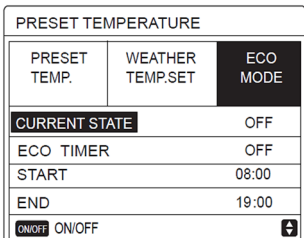

Press "ON/OFF". The following page will appear:

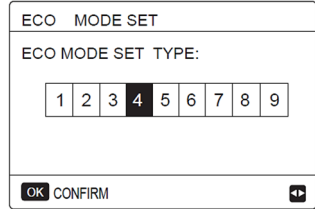

Use '◀', '▶' to scroll.

Press "OK" to select. The following page will appear:

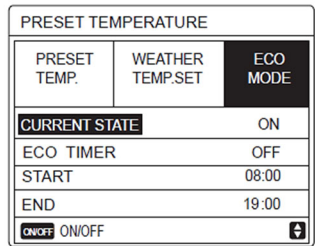

Use "ON/OFF" to turn ON or OFF, and use "▼", "▲" to scroll.

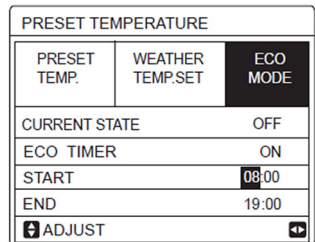

When the cursor is on the "START" or on the "END",you can use "◀","▶", "▼", "▲" to scroll and use "▼", "▲" to adjust the time.

i INFORMATION

ECO MODE SET have two kinds of curves:
 1. the curve of the high temperature setting for heating,
 2. the curve of the low temperature setting for heating,
 It only have the curve of the high temperature setting for heating, if the high temperature is set for heating.

- See "FOR SERVICEMAN">"HEAT MODE SETTING" in "Installation and owner's manual (M-thermal split indoor unit)".
- The desired temperature (T1S) can't be adjusted, when the ECO mode is ON.
- You can select the low or high temperature setting for heating to see the "Table 1~2".
- If ECO MODE is ON and ECO TIMER is OFF, the unit run ECO mode all the time.
- If ECO MODE is ON and ECO TIMER is ON, the unit run ECO mode according to the start time and end time.

DOMESTIC HOT WATER (DHW)

DHW mode typically consists of the following :

- 1) DISINFECT
- 2) FAST DHW
- 3) TANK HEATER
- 4) DHW PUMP

Disinfect

The DISINFECT function is used to kill the legionella. In disinfect function the tank temperature will be reached 65~70°C forcibly. The disinfect temperature is set in FOR SERVICEMAN.

See "FOR SERVICEMAN" > "DHW MODE" > "DISINFECT" in "Installation and owner's manual (M-thermal split indoor unit)".

Go to "MENU" > "DOMESTIC HOT WATER" > "DISINFECT".

Press "OK". The following page will appear

| DOMESTIC HOT WATER (DHW) | | | |
|--------------------------|----------|-------------|----------|
| DIS-INFECT | FAST DHW | TANK HEATER | DHW PUMP |
| CURRENT STATE | | | ON |
| OPERATE DAY | | | FRI |
| START | | | 23:00 |
| ON/OFF ON/OFF | | | |



| DOMESTIC HOT WATER (DHW) | | | |
|--------------------------|----------|-------------|----------|
| DIS-INFECT | FAST DHW | TANK HEATER | DHW PUMP |
| CURRENT STATE | | | OFF |
| OPERATE DAY | | | FRI |
| START | | | 23:00 |
| ON/OFF ON/OFF | | | |

Use "◀", "▶", "▼", "▲" to scroll and use "▼", "▲" to adjust the parameters when setting "OPERATE DAY" and "START".

If the OPERATE DAY is set FRIDAY and the START is set 23:00, the disinfect function will active on 23:00 Friday.

If the disinfect function is running, the following page will appear:

| | | | |
|------------|----|-------|-------|
| 01-01-2018 | | 23:59 | 13° |
| | ON | | |
| 23.5 °C | | | 38 °C |

Fast DHW

The FAST DHW function is used to force the system to operate in DHW mode.

The heat pump and the booster heater or addition heater will operate for DHW mode together, and the DHW desired temperature will be changed to 60°C.

Go to **MENU > DOMESTIC HOT WATER > FAST DHW**.

Press "OK"

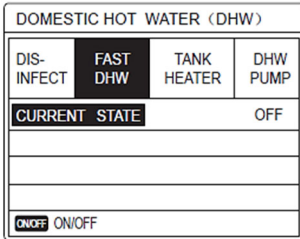
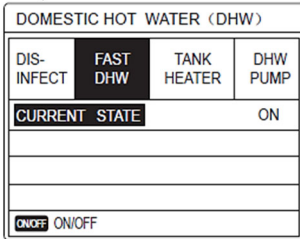

Use "ON/OFF" key to select ON or "OFF".

i INFORMATION

- invalid, and if CURRENT STATE is ON, the
- FAST DHW function is effective.
- The FAST DHW function is once effective.

TANK Heater

The tank heater function is used to force the tank heater to heat the water in tank. In the same situation, the cooling or heating is required and the heat pump system is operating for cooling or heating, however there still is a demand for the hot water.

Also, even if the heat pump system fails, TANK HEATER can be used to heat water in tank.

Go to **"MENU" > "DOMESTIC HOT WATER" > "TANK"**.

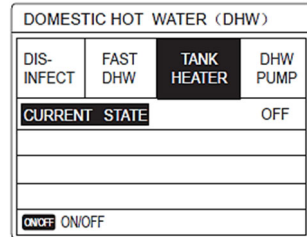
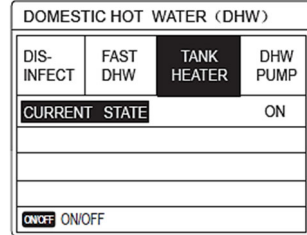

Use "ON/OFF" to select ON or OFF.

Use "BACK" to exit.

If TANK HEATER is effect, the following page will appear.

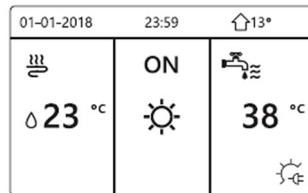

i INFORMATION

If CURRENT STATE is OFF, TANK HEATER is invalid.

If the T5 (sensor of tank) is fault , tank heater can't work.

DHW Pump

The DHW PUMP function is used to return water of the water net. Go to "MENU" > "DOMESTIC HOT WATER" > "DHW PUMP".

Press "OK".

The following page will appear:

| DOMESTIC HOT WATER (DHW) 1/2 | | | |
|--|----------|-----------------------------|----------|
| DIS-INFECT | FAST DHW | TANK HEATER | DHW PUMP |
| NO. | START | NO. | START |
| T1 <input checked="" type="checkbox"/> | 00:00 | T4 <input type="checkbox"/> | 00:00 |
| T2 <input type="checkbox"/> | 00:00 | T5 <input type="checkbox"/> | 00:00 |
| T3 <input type="checkbox"/> | 00:00 | T6 <input type="checkbox"/> | 00:00 |

| DOMESTIC HOT WATER (DHW) 2/2 | | | |
|--|----------|------------------------------|----------|
| DIS-INFECT | FAST DHW | TANK HEATER | DHW PUMP |
| NO. | START | NO. | START |
| T7 <input checked="" type="checkbox"/> | 00:00 | T10 <input type="checkbox"/> | 00:00 |
| T8 <input type="checkbox"/> | 00:00 | T11 <input type="checkbox"/> | 00:00 |
| T9 <input type="checkbox"/> | 00:00 | T12 <input type="checkbox"/> | 00:00 |

Move to "■", press "OK" to select or unselect. (☑ the timer is selected, ☐ the timer is unselected.)

| DOMESTIC HOT WATER (DHW) 1/2 | | | |
|--|----------|-----------------------------|----------|
| DIS-INFECT | FAST DHW | TANK HEATER | DHW PUMP |
| NO. | START | NO. | START |
| T1 <input checked="" type="checkbox"/> | 00:00 | T4 <input type="checkbox"/> | 00:00 |
| T2 <input type="checkbox"/> | 00:00 | T5 <input type="checkbox"/> | 00:00 |
| T3 <input type="checkbox"/> | 00:00 | T6 <input type="checkbox"/> | 00:00 |

Use "◀", "▶", "▼", "▲" to scroll and use "▼", "▲" to adjust the parameters.

For example: you have set the parameter about the DHW PUMP (See "FOR SERVICEMAN">"DHW MODE SETTING" on "Installation and owner's manual (M-thermal split indoor unit)").

PUMP RUNNING TIME is 30 minutes.

Set as follows:

| NO. | START |
|-----|-------|
| 1 | 6:00 |
| 2 | 7:00 |
| 3 | 8:00 |
| 4 | 9:00 |

The PUMP will run as follows:

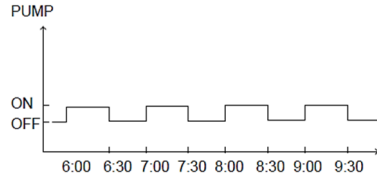

SCHEDULE

SCHEDULE menu contents as follows:

The following page will appear:

- 1) TIMER
- 2) WEEKLY SCHEDULE
- 3) SCHEDULE CHECK
- 4) CANCEL TIMER

Timer

If the weekly schedule function is on, the timer is off, the later setting is effective. If the Timer is activated, ☹ is displayed on home page.

| SCHEDULE 1/2 | | | |
|----------------------------|-----------------|----------------|--------------|
| TIMER | WEEKLY SCHEDULE | SCHEDULE CHECK | CANCEL TIMER |
| NO. | START | END | MODE TEMP |
| 1 <input type="checkbox"/> | 00:00 | 00:00 | HEAT 0°C |
| 2 <input type="checkbox"/> | 00:00 | 00:00 | HEAT 0°C |
| 3 <input type="checkbox"/> | 00:00 | 00:00 | HEAT 0°C |

| SCHEDULE | | | | | 2/2 |
|----------|--------------------------------|----------------|--------------|------|-----|
| TIMER | WEEKLY SCHEDULE | SCHEDULE CHECK | CANCEL TIMER | | |
| NO. | START | END | MODE | TEMP | |
| 4 | <input type="checkbox"/> 00:00 | 00:00 | HEAT | 0°C | |
| 5 | <input type="checkbox"/> 00:00 | 00:00 | HEAT | 0°C | |
| 6 | <input type="checkbox"/> 00:00 | 00:00 | HEAT | 0°C | |

Use "◀", "▶", "▼", "▲" to scroll and use "▼", "▲" to adjust the temperature.

Move to "■", press "OK" to select or unselect. (☑ the timer is selected, ☐ the timer is unselected.). six timers can be set.

If you want to cancel the **TIMER**, you move the cursor to "☑",press "OK",the ☑ become ☐ , the timer is invalid.

If you set the start time later than the end time or the temperature out of range of the mode.

The following page will appear:

| SCHEDULE | | | |
|---|-----------------|----------------|--------------|
| TIMER | WEEKLY SCHEDULE | SCHEDULE CHECK | CANCEL TIMER |
| Timer1 is useless. | | | |
| Please check the timer setting and temperature setting. | | | |
| <input type="checkbox"/> OK CONFIRM | | | |

Example:

Six timer is set as following:

| NO. | START | END | MODE | TEMP |
|-----|--------|--------|------|------|
| T1 | 1: 00 | 3: 00 | DHW | 50°C |
| T2 | 7: 00 | 9: 00 | HEAT | 28°C |
| T3 | 11: 30 | 13: 00 | COOL | 20°C |
| T4 | 14: 00 | 16: 00 | HEAT | 28°C |
| T5 | 15: 00 | 19: 00 | COOL | 20°C |
| T6 | 18: 00 | 23: 30 | DHW | 50°C |

The unit will run as following:



The operation of the controller at the following time:

| TIME | The operatin of the controller |
|-------|--|
| 1:00 | DHW mode is turned ON |
| 3:00 | DHW mode is turned OFF |
| 7:00 | HEAT MODE is turned ON |
| 9:00 | HEAT MODE is turned OFF |
| 11:30 | COOL MODE is turned ON |
| 13:00 | COOL MODE is turned OFF |
| 14:00 | HEAT MODE is turned ON |
| 15:00 | COOL MODE is turned ON and HEAT MODE is turned OFF |
| 18:00 | DHW MODE is turned ON and COOL MODE is turned OFF |
| 23:30 | DHW mode is turned OFF |

i INFORMATION

If the start time is same to the end time in one timer, the timer is invalid.

Weekly Schedule

If the timer function is on and the weekly schedule is off, the later setting is effective. If WEEKLY SCHEDULE is activated, icon is displayed on the home page.

Go to "MENU" > "SCHEDULE" > "WEEKLY SCHEDULE".

Press "OK". The following page will appear:

| SCHEDULE | | | | | | |
|---|-----------------|----------------|--------------|--|--|--|
| TIMER | WEEKLY SCHEDULE | SCHEDULE CHECK | CANCEL TIMER | | | |
| MON. TUE. WED. THU. FRI. SAT. SUN. | | | | | | |
| <input checked="" type="checkbox"/> <input type="checkbox"/> <input type="checkbox"/> <input type="checkbox"/> <input type="checkbox"/> <input type="checkbox"/> <input type="checkbox"/> | | | | | | |
| ENTER | | | CANCEL | | | |
| <input type="checkbox"/> OK MON SELECT | | | | | | |

First select the days of the week you wish to schedule.

Use "◀", "▶" to scroll, press "OK" to select or unselect the day.

" MON" means that the day is selected, " MON" means that the day is unselected:

i INFORMATION

We must set two days at least when we want to enable WEEKLY SCHEDULE function.

| SCHEDULE | | | | | | | |
|--------------------------|--------------------------|--------------------------|--------------------------|-------------------------------------|--------------------------|--------------------------|--|
| TIMER | WEEKLY SCHEDULE | SCHEDULE CHECK | CANCLE TIMER | | | | |
| MON. | TUE. | WED. | THU. | FRI. | SAT. | SUN. | |
| <input type="checkbox"/> | <input type="checkbox"/> | <input type="checkbox"/> | <input type="checkbox"/> | <input checked="" type="checkbox"/> | <input type="checkbox"/> | <input type="checkbox"/> | |
| ENTER | | | | CANCEL | | | |
| OK MON SELECT | | | | | | | |

Use "◀" or "▶" to SET, press "ENTER".
 The Monday to Friday are selected to be scheduled and they have the same schedule.
 The following pages will appear:

| SCHEDULE | | | | | | 1/2 |
|----------|--------------------------|----------------|--------------|------|-----|-----|
| TIMER | WEEKLY SCHEDULE | SCHEDULE CHECK | CANCLE TIMER | | | |
| NO. | START | END | MODE | TEMP | | |
| 1 | <input type="checkbox"/> | 00:00 | 00:00 | HEAT | 0°C | |
| 2 | <input type="checkbox"/> | 00:00 | 00:00 | HEAT | 0°C | |
| 3 | <input type="checkbox"/> | 00:00 | 00:00 | HEAT | 0°C | |

| SCHEDULE | | | | | | 2/2 |
|----------|--------------------------|----------------|--------------|------|-----|-----|
| TIMER | WEEKLY SCHEDULE | SCHEDULE CHECK | CANCLE TIMER | | | |
| NO. | START | END | MODE | TEMP | | |
| 4 | <input type="checkbox"/> | 00:00 | 00:00 | HEAT | 0°C | |
| 5 | <input type="checkbox"/> | 00:00 | 00:00 | HEAT | 0°C | |
| 6 | <input type="checkbox"/> | 00:00 | 00:00 | HEAT | 0°C | |

Use "◀", "▶", "▼", "▲" to scroll and adjust the time ,the mode and the temperature. Timers can be set, including start time and end time,mode and temperature.
 The mode includes heat mode, cool mode and DHW mode.
 The setting method refer to timer setting. The end time must be later than the start time. Otherwise this will show that Timer is useless.

Schedule check

Schedule check can only check the weekly schedule.
 Go to "MENU" > "SCHEDULE" > "SCHEDULE CHECK".
 Press "OK". The following page will appear

| SCHEDULE | | | |
|-----------------------|-----------------|----------------|--------------|
| TIMER | WEEKLY SCHEDULE | SCHEDULE CHECK | CANCLE TIMER |
| WEEKLY SCHEDULE CHECK | | | |
| OK ENTER | | | |

| WEEKLY SCHEDULE CHECK | | | | | |
|---------------------------------|----|--------------------------|------|-------|-------------|
| DAY | NO | MODE | SET | START | END |
| MON <input type="checkbox"/> | T1 | <input type="checkbox"/> | HEAT | 0°C | 00:00 00:00 |
| | T2 | <input type="checkbox"/> | HEAT | 0°C | 00:00 00:00 |
| | T3 | <input type="checkbox"/> | HEAT | 0°C | 00:00 00:00 |
| | T4 | <input type="checkbox"/> | HEAT | 0°C | 00:00 00:00 |
| | T5 | <input type="checkbox"/> | HEAT | 0°C | 00:00 00:00 |
| | T6 | <input type="checkbox"/> | HEAT | 0°C | 00:00 00:00 |

Press "▼", "▲", the timer from Monday to Sunday will appear

Cancel Timer

Go to "MENU" > "SCHEDULE" > "CANCEL TIMER".
 Press "OK".
 The following page will appear:

| SCHEDULE | | | |
|--|-----------------|----------------|--------------|
| TIMER | WEEKLY SCHEDULE | SCHEDULE CHECK | CANCLE TIMER |
| Do you want to cancel the timer and weekly schedule? | | | |
| NO | | YES | |
| OK ENTER | | | |

Use "◀", "▶", "▼", "▲" to move to "YES", press "OK" to cancel timer. If you want to exit CANCEL TIMER, press "BACK".
 If TIMER or WEEKLY SCHEDULE is activated, timer icon "⊙" or weekly schedule icon "7" will display on the home page.

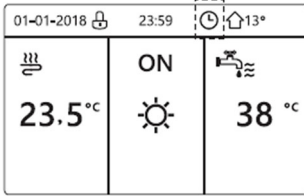

If TIMER or WEEKLY SCHEDULE is canceled, timer icon "🕒" or weekly schedule icon "📅" will disappear on the home page.

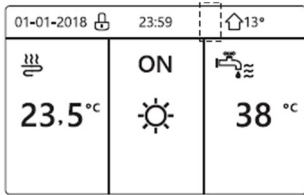

i INFORMATION

You have to reset TIMER/WEEKLY SCHEDULE, if you change the WATER FLOW TEMP. to the ROOM TEMP. or you change the ROOM TEMP. to the WATER FLOW TEMP.
The TIMER or WEEKLY SCHEDULE is invalid, if ROOM THERMOSTAT is effect.

i INFORMATION

- The ECO or COMFORT MODE has the highest priority, the TIMER or WEEKLY SCHEDULE has the second priority and the PRESET TEMP. or WEATHER TEMP. SET has the lowest priority.
- The PRESET TEMP. or WEATHER TEMP. SET becomes invalid, when we set the ECO or COMFORT valid. We must reset the PRESET TEMP. or WEATHER TEMP. SET when we set the ECO or COMFORT invalid.
- TIMER or WEEKLY SCHEDULE is invalid when ECO or COMFORT is valid. TIMER or WEEKLY SCHEDULE is activated when the ECO or COMFORT is not running.

i INFORMATION

- TIMER and WEEKLY SCHEDULE are on the same priority. The later setting function is valid. The PRESET TEMP. becomes invalid when TIMER or WEEKLY SCHEDULE is valid. The WEATHER TEMP. SET is not affected by the setting of TIMER or WEEKLY SCHEDULE.
- PRSET TEMP. and WATHER TEMP.SET are on the same priority. The later setting function is valid.

i INFORMATION

All about the time set items (PRESET TEMP. , ECO/COMFORT, DISINFECT, DHW PUMP, TIMER, WEEKLY SCHEDULE, SILENCE MODE, HOLIDAY HOME), the ON/OFF of the corresponding function can be activated from the start time to the end time.

OPTIONS

OPTIONS menu contents as following:

- 1) SILENT MODE
- 2) HOLIDAY AWAY
- 3) HOLIDAY HOME
- 4) BACKUP HEATER

Silent Mode

The SILENT MODE is used to decrease the sound of the unit. However, it also decreases the heating/cooling capacity of the system. There are two silent mode levels.

The **level2** is more silent than **level1**, and the heating or cooling capacity is also more decreasing.

There are two method to use the silent mode:

- 1) silent mode in all time;
- 2) silent mode in timer.

Go to the home page to check if silent mode is activated. If the silent mode is activated, "☾" will display on the home page.

Go to **"MENU" > "OPTIONS" > "SILENT MODE"**.

Press **"OK"**. The following page will appear:

| OPTIONS | | | | 1/2 |
|---------------|--------------|--------------|---------------|---------|
| SILENT MODE | HOLIDAY AWAY | HOLIDAY HOME | BACKUP HEATER | |
| CURRENT STATE | | | | OFF |
| SILENT LEVEL | | | | LEVEL 1 |
| TIMER1 START | | | | 12:00 |
| TIMER1 END | | | | 15:00 |
| ON/OFF | | | | ON/OFF |

Use **"ON/OFF"** to select ON or OFF.

Description:

If CURRENT STATE is OFF, SILENT MODE is invalid.

When you select SILENT LEVEL, and press **"OK"** or **"▶"**.

The following page will appear:

| OPTIONS | | | | |
|---------------|--------------|--------------|---------------|---------|
| SILENT MODE | HOLIDAY AWAY | HOLIDAY HOME | BACKUP HEATER | |
| CURRENT STATE | | | | ON |
| SILENT LEVEL | | | | LEVEL 1 |
| TIMER1 START | | | | 12:00 |
| TIMER1 END | | | | 15:00 |
| ADJUST | | | | |

LEVEL 1

| OPTIONS | | | | |
|---------------|--------------|--------------|---------------|---------|
| SILENT MODE | HOLIDAY AWAY | HOLIDAY HOME | BACKUP HEATER | |
| CURRENT STATE | | | | ON |
| SILENT LEVEL | | | | LEVEL 2 |
| TIMER1 START | | | | 12:00 |
| TIMER1 END | | | | 15:00 |
| ADJUST | | | | |

LEVEL 2

You can use **"▼"**, **"▲"** to select **level 1** or **level 2**.

Press **"OK"**.

If the silent TIMER is selected, Press **"OK"** to enter, the following page will appear.

| OPTIONS | | | | 2/2 |
|--------------|--------------|--------------|---------------|-------|
| SILENT MODE | HOLIDAY AWAY | HOLIDAY HOME | BACKUP HEATER | |
| TIMER1 | | | | OFF |
| TIMER2 START | | | | 22:00 |
| TIMER2 END | | | | 07:00 |
| TIMER2 | | | | OFF |
| ADJUST | | | | |

There are two timers for setting. Move to **"■"**, press **"OK"** to select or unselect.

If the two time are both unselected, the silent mode will operate in all time. Otherwise, it will operate according as the time.

Holiday Away

If the holiday away mode is activated, will display on the home page.

The holiday away function is used to prevent frozen in the winter during the outside holiday, and return the unit before the end of the holiday.

Go to **"MENU" > "OPTIONS" > "HOLIDAY AWAY"**.

Press **"OK"**. The following page will appear:

| OPTIONS | | | | 1/2 |
|---------------|--------------|--------------|---------------|--------|
| SILENT MODE | HOLIDAY AWAY | HOLIDAY HOME | BACKUP HEATER | |
| CURRENT STATE | | | | OFF |
| DHW MODE | | | | ON |
| DISINFECT | | | | ON |
| HEAT MODE | | | | ON |
| ON/OFF | | | | ON/OFF |

| OPTIONS | | | | 2/2 |
|-------------|--------------|--------------|---------------|------------|
| SILENT MODE | HOLIDAY AWAY | HOLIDAY HOME | BACKUP HEATER | |
| FROM | | | | 00-00-2000 |
| UNTIL | | | | 00-00-2000 |
| ADJUST | | | | |

Usage example:

You go away during the winter.

The current date is 2018-01-31, two days later is 2018-02-02, it is the beginning date of the holiday.

If you are in the following situation:

In 2 days, you go away for 2 weeks during the winter.

You want to save energy, but prevent your house from freezing.

Then you can do the following:

- 1) Configure the holiday away the following settings:
- 2) Activate the holiday mode.

Go to **"MENU" > "OPTIONS" > "HOLIDAY AWAY"**.

Press **"OK"** .

Use **"ON/OFF"** to select **"OFF"** or **"ON"** and use **"◀", "▶", "▼", "▲"** to scroll and adjust.

| Setting | Value |
|----------------|------------------|
| Holiday Away | ON |
| From | 2 February 2018 |
| Until | 16 February 2018 |
| Operation Mode | Heating |
| Disinfect | ON |

i INFORMATION

If DHW mode in holiday away mode is ON, The disinfect set by user is invalid.

If holiday away mode is ON, The timer and weekly schedule are invalid except exit.

If the CURRENT STATE is OFF, the HOLIDAY AWAY is OFF.

If the CURRENT STATE is ON, the HOLIDAY AWAY is ON.

The remote control doesn't accept any orders when holiday away mode is ON.

i INFORMATION

Disinfecting the unit on 23:00 of the last day if disinfect is ON.

When in holiday away mode, the climate related curves previously set is invalid, and the curves will automatically take effect after the holiday away mode is ends.

The preset temperature is invalid when in holiday away mode, but the preset value still display on the main page.

Holiday Home

The holiday home function is used to deviate from the normal schedules without having to change them during the holiday at home.

During your holiday, you can use the holiday mode to deviate from your normal schedules without having to change them.

| Period | Value |
|-------------------------------|--|
| Before and after your holiday | Your normal schedules will be used |
| During your holiday | The configured holiday settings will be used |

If the holiday home mode is activated,  will display on the home page.

Go to **"MENU" > "OPTIONS" > "HOLIDAY HOME"**.

Press **"OK"**.

The following page will appear:

| OPTIONS | | | |
|---------------|--------------|--------------|---|
| SILENT MODE | HOLIDAY AWAY | HOLIDAY HOME | BACKUP HEATER |
| CURRENT STATE | | | OFF |
| FROM | | | 00-00-2000 |
| UNTIL | | | 00-00-2000 |
| TIMER | | | ENTER |
| ON/OFF | | |  |

Use "ON/OFF" to select "OFF" or "ON" and use "◀", "▶", "▼", "▲" to scroll and adjust.

If the CURRENT STATE is **OFF**, the HOLIDAY HOME is **OFF**.

If the CURRENT STATE is **ON**, the HOLIDAY HOME is **ON**.

Use "▼", "▲" to adjust the date.

Before and after your holiday, your normal schedule will be used.

During your holiday, you save energy and prevent your house from freezing.

i INFORMATION

You have to reset Holiday away or Holiday home, if you change the operation mode of the unit.

Backup Heater

The BACKUP HEATER function is used to force the backup heater. Go to "MENU" > "OPTIONS" > "BACKUP HEATER".

Press "OK".

If **IBH** and **AHS** is set invalid by DIP switch on the main control board of hydraulic module.

The following page will appear.

| OPTIONS | | | |
|-------------|--------------|--------------|---------------|
| SILENT MODE | HOLIDAY AWAY | HOLIDAY HOME | BACKUP HEATER |
| | | | |
| | | | |
| | | | |
| | | | |

IBH = Indoor unit backup heater.

AHS = Additional heating source.

If **IBH** and **AHS** is set valid by DIP switch on the main control board of hydraulic module, the following page will appear:

| OPTIONS | | | |
|---------------|--------------|--------------|---------------|
| SILENT MODE | HOLIDAY AWAY | HOLIDAY HOME | BACKUP HEATER |
| | | | |
| BACKUP HEATER | | | ON |
| | | | |
| | | | |
| ON/OFF ON/OFF | | | |

Use "ON/OFF" to select "OFF" or "ON".

i INFORMATION

If the operation mode is auto mode in space heating or cooling side, the backup heater function can not be selected. The BACKUP HEATER function is invalid when only ROOM HEAT MODE enabled.

Child Lock

The CHILD Lock function is used to prevent children error operation. The mode setting and temperature adjusting can be locked or unlocked by using CHILD LOCK function.

Go to "MENU" > "CHILD LOCK".

The page is displayed:

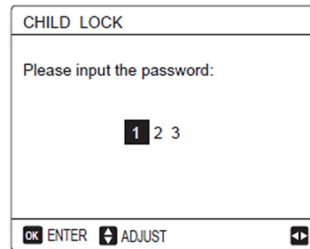

Input the correct password, the following page will appear:

| CHILD LOCK | | |
|------------------------|-------------|--|
| COOL/HEAT TEMP. ADJUST | UNLOCK | |
| COOL/HEAT MODE ON/OFF | UNLOCK | |
| DHW TEMP. ADJUST | UNLOCK | |
| DHW MODE ON/OFF | UNLOCK | |
| | | |
| | | |
| UNLOCK | LOCK/UNLOCK | |

Use "▼", "▲" to scroll and "ON/OFF" to select **LOCK** or **UNLOCK**.

The cool/heat temperature can't be adjusted when the COOL/HEAT TEMP. ADJUST is locked. If you want to adjust the cool/heat temperature when cool/heat temperature is locked, the following page will appear:

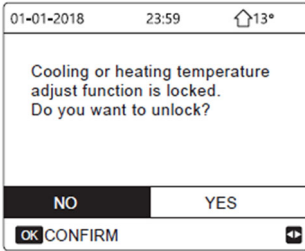

The Cool/Heat mode can't turn **ON** or **OFF** when the **COOL/HEAT MODE ON/OFF** is locked.

If you want to turn on or off the Cool/Heat mode when **COOL/HEAT MODE ON/OFF** is locked, the following page will appear:

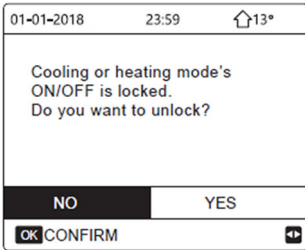

The **DHW** temperature can't be adjusted when the **DHW TEMP. ADJUST** is locked. If you want to adjust the **DHW** temperature when **DHW TEMP. ADJUST** is **Locked**, the following page will appear:

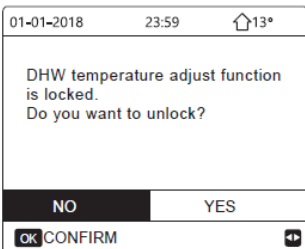

The **DHW** mode can't turn on or off when the **DHW MODE ON/OFF** is locked. If you want to turn **ON** or **OFF** the **DHW** mode when **DHW MODE ON/OFF** is **Locked**, the following page will appear:

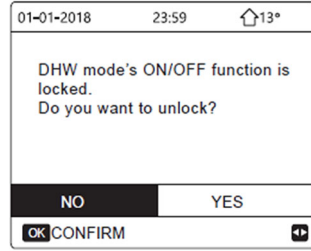

SERVICE INFORMATION

About service information

Service information menu contents as following:

- 1) SERVICE CALL
- 2) ERROR CODE
- 3) PARAMETER
- 4) DISPLAY

How to go to service information menu

Go to "MENU" > "SERVICE INFORMATION". Press "OK".

The following page will appear:

The service call can show the service phone or mobile number. The installer can input the phone number.

See "FOR SERVICEMAN".

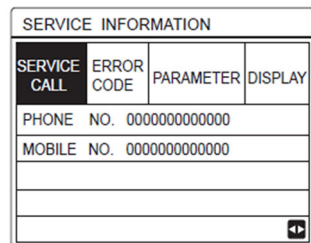

Error code is used to show when the fault or proction happen and show the mean of the error code.

| SERVICE INFORMATION | | | |
|---------------------|------------|-----------|------------|
| SERVICE CALL | ERROR CODE | PARAMETER | DISPLAY |
| E2 | 14:10 | | 01-01-2018 |
| E2 | 14:00 | | 01-01-2018 |
| E2 | 13:50 | | 01-01-2018 |
| E2 | 13:20 | | 01-01-2018 |
| OK ENTER | | | ↔ |

Press **OK** the page will appear:

| SERVICE INFORMATION 1/2 | | | |
|-------------------------|------------|-----------|------------|
| SERVICE CALL | ERROR CODE | PARAMETER | DISPLAY |
| E2 | 14:10 | | 01-01-2018 |
| E2 | 14:00 | | 01-01-2018 |
| E2 | 13:50 | | 01-01-2018 |
| E2 | 13:20 | | 01-01-2018 |
| OK ENTER | | | ↕ |

Press **OK** to show the mean of the error code:

| | | |
|---|-------|-------|
| 01-01-2018 | 23:59 | 🏠 13° |
| E2 communication fault between controller and indoor unit | | |
| Please contact your dealer. | | |
| OK CONFIRM | | |

i INFORMATION

A total of eight fault codes can be recorded.

The parameter function is used to display the main parameter, there are two pages to show the parameter:

| SERVICE INFORMATION 1/2 | | | |
|-------------------------|------------|-------------------|---------|
| SERVICE CALL | ERROR CODE | PARAMETER | DISPLAY |
| | | ROOM SET TEMP. | 26°C |
| | | MAIN SET TEMP. | 55°C |
| | | TANK SET TEMP. | 55°C |
| | | ROOM ACTUAL TEMP. | 24°C |

| SERVICE INFORMATION 2/2 | | | |
|-------------------------|------------|-------------------------|---------|
| SERVICE CALL | ERROR CODE | PARAMETER | DISPLAY |
| | | MAIN ACTUAL TEMP. | 26°C |
| | | TANK ACTUAL TEMP. | 55°C |
| | | SMART GRID RUNNING TIME | 0 Hrs |

The DISPLAY function is used to set the interface:

| SERVICE INFORMATION 1/2 | | | |
|-------------------------|------------|-----------|------------|
| SERVICE CALL | ERROR CODE | PARAMETER | DISPLAY |
| | | TIME | 12:30 |
| | | DATE | 08-08-2018 |
| | | LANGUAGE | EN |
| | | BACKLIGHT | ON |
| OK ENTER | | | ↔ |

| SERVICE INFORMATION 2/2 | | | |
|-------------------------|------------|-------------------------|---------|
| SERVICE CALL | ERROR CODE | PARAMETER | DISPLAY |
| | | BUZZER | ON |
| | | SCREEN LOCK TIME | 120SEC |
| | | SMART GRID RUNNING TIME | 2 Hrs |
| ON/OFF ON/OFF | | | ↕ |

Use "OK" to enter and use "◀", "▶", "▼", "▲" to scroll.

Operation Parameter

This menu is for installer or service engineer reviewing the operation parameter.

At home page, go to "MENU" > "OPERATION PARAMETER".

Press "OK". There are six pages for the operating parameter as following.

Use "▼", "▲" to scroll.

| | |
|----------------------|--------|
| OPERATION PARAMETER | 1/6 |
| OPERATE MODE | COOL |
| CURRENT | 12 A |
| COMPRESSOR FREQUENCY | 24 Hz |
| COMP. RUN TIME1 | 54 MIN |
| COMP. RUN TIME2 | 65 MIN |
| COMP. RUN TIME3 | 10 MIN |
| ➔ | |

| | |
|------------------------|-----------|
| OPERATION PARAMETER | 2/6 |
| COMP.RUN TIME4 | 1000 HOUR |
| EXPANSION VALVE | 240 P |
| FAN SPEED | 600 R/MIN |
| IDU TARGET FREQUENCY | 0 HZ |
| FREQUENCY LIMITED TYPE | 0 |
| T1 LEAVING WATER TEMP. | 25 °C |
| ➔ | |

| | |
|---------------------------|-------|
| OPERATION PARAMETER | 3/6 |
| T1B CIRCUIT2 WATER TEMP. | 30 °C |
| T2 PLATE F-OUT TEMP. | 30 °C |
| T2B PLATE F-IN TEMP. | 45 °C |
| T3 OUTDOOR EXCHANGE TEMP. | -7 °C |
| T4 OUTDOOR AIR TEMP. | -7 °C |
| T5 WATER TANK TEMP. | -7 °C |
| ➔ | |

| | |
|---------------------------|---------|
| OPERATION PARAMETER | 4/6 |
| Ta ROOM TEMP. | 25 °C |
| Th COMP. SUCTION TEMP. | 25 °C |
| Tp COMP. DISCHARGE TEMP. | 25 °C |
| TW-O PLATE W-OUTLET TEMP. | 25 °C |
| TW-I PLATE W-INLET TEMP. | 25 °C |
| P1 COMP. PRESSURE1 | 200 kPa |
| ➔ | |

| | |
|---------------------------|----------|
| OPERATION PARAMETER | 5/6 |
| T1S' C1 CLI. CURVE TEMP. | 25 °C |
| T1S2' C2 CLI. CURVE TEMP. | 25 °C |
| TF MODULE TEMP. | 55 °C |
| SUPPLY VOLTAGE | 230 V |
| POWER CONSUM. | 1000 KWh |
| DC GENERATRIX VOLTAGE | 420 V |
| ➔ | |

| | |
|-----------------------|---------------|
| OPERATION PARAMETER | 6/6 |
| DC GENERATRIX CURRENT | 18 A |
| WATER FLOW | 1.72 M3/H |
| HEAT PUMP CAPACITY | 11.52 KW |
| HMI SOFTWARE | 00-00-2000V00 |
| IDU SOFTWARE | 00-00-2000V00 |
| ODU SOFTWARE | 00-00-2000V00 |
| ➔ | |

i INFORMATION

The power consumption parameter is optional.

if some parameter not be activated in the system, the parameter will show "--"

The heat pump capacity is for reference only, not used to judge the ability of the unit. The accuracy of sensor is ±1°C. The flow rates parameters are calculated according to the pump running parameters, the deviation is different at different flow rates, the maximum of deviation is 15%.

For Serviceman

About For Serviceman

FOR SERVICEMAN is used for installer and service engineer.

- Setting the function of equipment.
- Setting the parameters.

How To Go To For Serviceman

Go to "MENU" > "FOR SERVICEMAN". Press "OK".

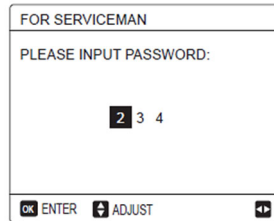

The FOR SERVICEMAN is used for installer or service engineer. It is NOT intended the home owner alters setting with this menu.

It is for this reason password protection is required to prevent unauthorised access to the service settings.

The password is **2 3 4**

How To Exit For SERVICEMAN

If you have set all the parameter.
Press "BACK", the following page will appear:

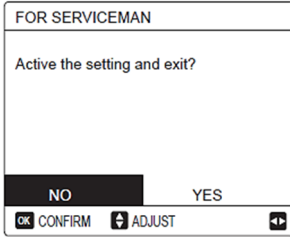

Select "YES" and press "OK" to exit the FOR SERVICEMAN.
After exiting the FOR SERVICEMAN, the unit will be **Turned OFF**.

Network Configuration Guidelines

The wired controller realizes intelligent control with a built-in module, which receives control signal from the APP.

Before connecting the WLAN, please check for it if the router in your environment is active and make sure that the wired controller is well-connected to the wireless signal.

During the Wireless distribution process, the LCD icon "📶" flashes to indicate that the network is being deployed.

After the process is completed, the icon "📶" will be constantly on.

Wired Controller Setting

The wired controller settings include **AP MODE** and **RESTORE WLAN SETTING**.

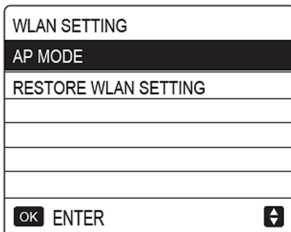

Activate the WLAN by interface.
Go to "MENU"> "WLAN SETTING"> "AP MODE".
Press "OK", the following page will appear:

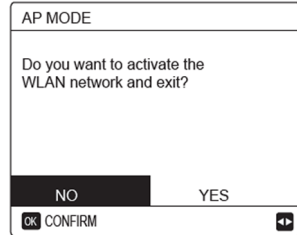

Use "◀", "▶" to move to "YES", press "OK" to select **AP mode**.
Select AP Mode correspondingly on the mobile device and continue the follow-up settings according to the APP prompts.

⚠ CAUTION

After enter Ap mode, if it's not connected with mobile phone, the LCD icon "📶" will flash 10 minutes then disappear.
If it's connected with the mobile phone, the icon "📶" will be constantly display.

Restore WLAN setting by interface.
Go to "MENU"> "WLAN SETTING" > "RESTORE WLAN SETTING" .
Press "OK", the following page will appear:

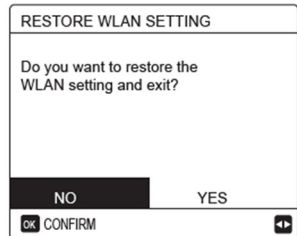

Use "◀" "▶" to move to "YES", press "OK" to restore WLAN setting.
Complete the above operation and wireless configuration is reset.

Mobile Device Setting

AP Mode is available for wireless distribution on mobile device side.

AP Mode connecting WLAN:

Install APP

1. Scan the following QR code to install the Smart Home APP.



1. Please research "Msmartlife" in APP STORE or GOOGLE PLAY to install the APP.

Sign in/Sign up

Click the "+" button on the right side of the home page , register account according to the guide.



Add Home Appliances:

1. Choose the wired controller model, then go to add the device.



2. Operate the wired controller according to APP prompts

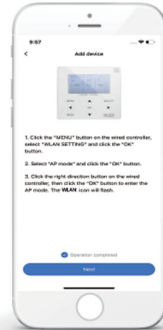

3. Wait for the home appliance to connect, and click "Finish".

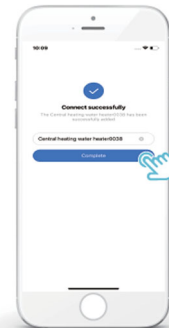

4. After the appliance is successfully connected, the LCD icon“  ” of the wired controller is constantly **On**, and the air conditioner can be controlled through the APP.
5. If the network distribution process fails, or the mobile connection demands reconnection and replacement, operate **“WLAN Factory Reset”** on the wired controller, and then repeat the above process

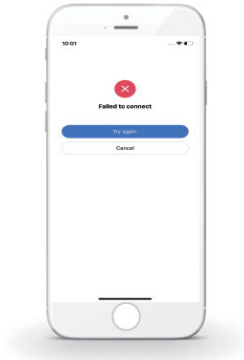

Warning and trouble-shooting for networking failures

When the product is connected to the network, please make sure that the phone is as close as possible to the product.

We only support 2.4GHz band routers at present.

Special characters (punctuation, spaces, etc.) are not recommended as part of the WLAN name.

It is recommended that you connect no more than 10 devices to a single router lest home appliances are affected by weak or unstable network signal.

If the password of the router or WLAN is changed, clear all settings and reset the appliance.

The contents of APP might change in version updates and actual operation shall prevail.

MENU STRUCTURE : OVERVIEW

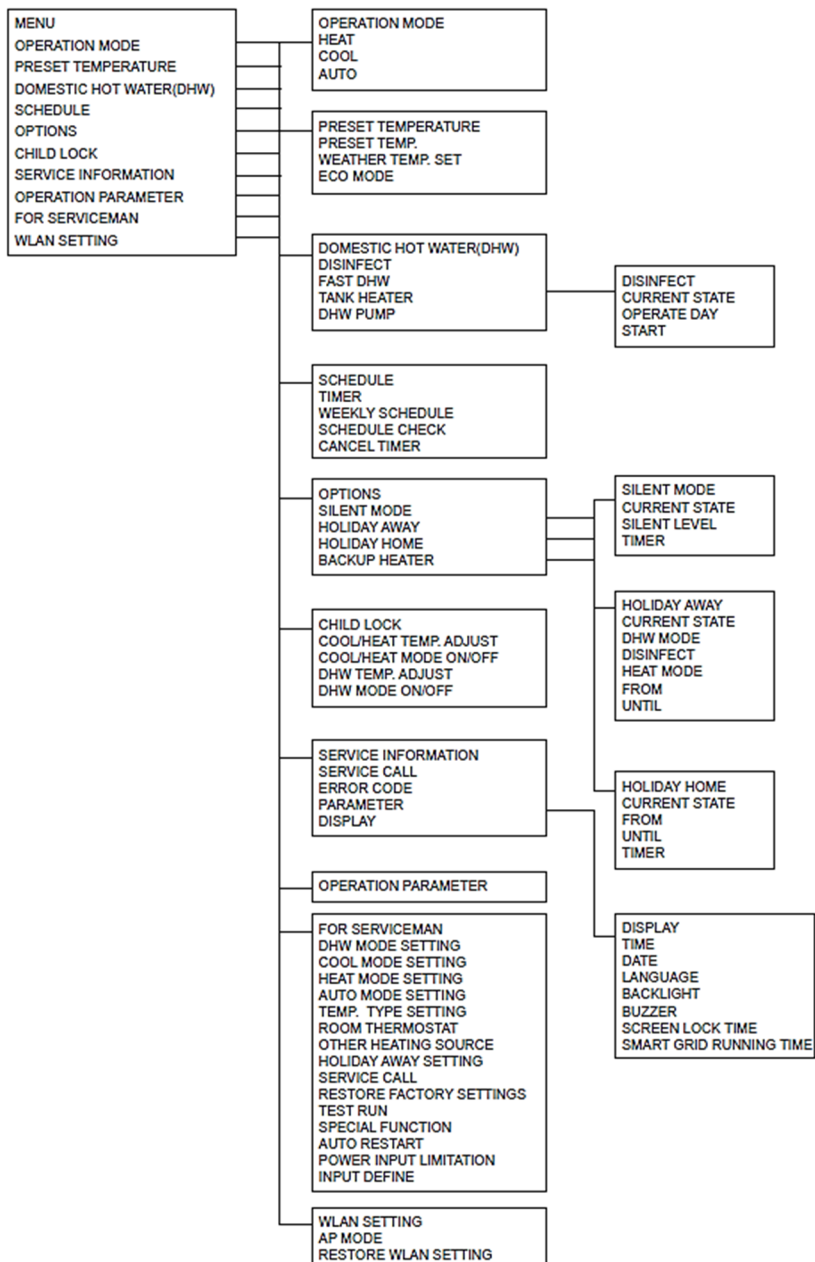

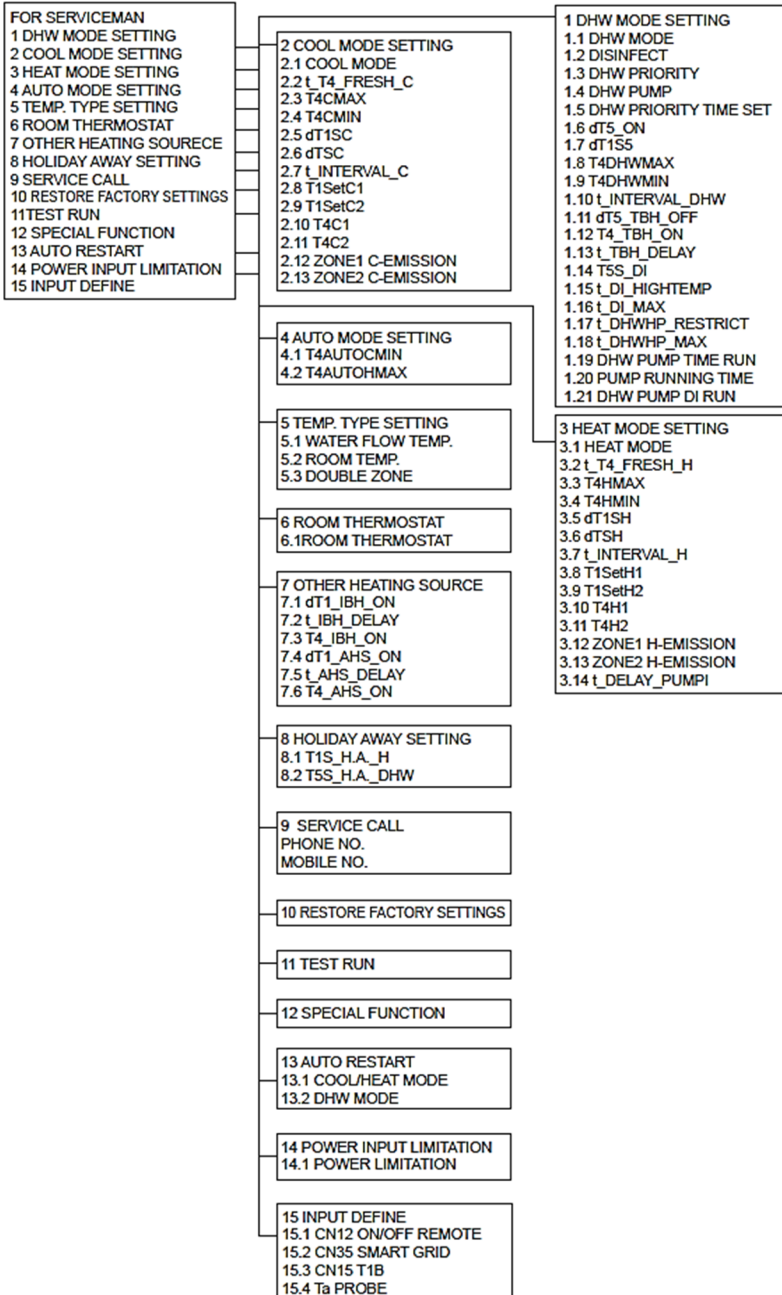

Table 1: The environment temperature curve of the low temperature setting for heating

| T4 | ≤ -20 | -19 | -18 | -17 | -16 | -15 | -14 | -13 | -12 | -11 | -10 | -9 | -8 | -7 | -6 | -5 | -4 | -3 | -2 | -1 | 0 |
|-------|-------|-----|-----|-----|-----|-----|-----|-----|-----|-----|-----|----|----|----|----|----|----|----|----|------|----|
| 1-TIS | 38 | 38 | 38 | 38 | 38 | 37 | 37 | 37 | 37 | 37 | 37 | 36 | 36 | 36 | 36 | 36 | 36 | 35 | 35 | 35 | 35 |
| 2-TIS | 37 | 37 | 37 | 37 | 37 | 36 | 36 | 36 | 36 | 36 | 36 | 35 | 35 | 35 | 35 | 35 | 35 | 34 | 34 | 34 | 34 |
| 3-TIS | 36 | 36 | 36 | 35 | 35 | 35 | 35 | 35 | 35 | 34 | 34 | 34 | 34 | 34 | 34 | 33 | 33 | 33 | 33 | 33 | 33 |
| 4-TIS | 35 | 35 | 35 | 34 | 34 | 34 | 34 | 34 | 34 | 33 | 33 | 33 | 33 | 33 | 33 | 32 | 32 | 32 | 32 | 32 | 32 |
| 5-TIS | 34 | 34 | 34 | 33 | 33 | 33 | 33 | 33 | 33 | 32 | 32 | 32 | 32 | 32 | 32 | 31 | 31 | 31 | 31 | 31 | 31 |
| 6-TIS | 32 | 32 | 32 | 32 | 31 | 31 | 31 | 31 | 31 | 31 | 31 | 31 | 30 | 30 | 30 | 30 | 30 | 30 | 30 | 30 | 29 |
| 7-TIS | 31 | 31 | 31 | 31 | 30 | 30 | 30 | 30 | 30 | 30 | 30 | 30 | 29 | 29 | 29 | 29 | 29 | 29 | 29 | 29 | 28 |
| 8-TIS | 29 | 29 | 29 | 29 | 28 | 28 | 28 | 28 | 28 | 28 | 28 | 28 | 27 | 27 | 27 | 27 | 27 | 27 | 27 | 27 | 26 |
| T4 | 1 | 2 | 3 | 4 | 5 | 6 | 7 | 8 | 9 | 10 | 11 | 12 | 13 | 14 | 15 | 16 | 17 | 18 | 19 | ≥ 20 | |
| 1-TIS | 35 | 35 | 34 | 34 | 34 | 34 | 34 | 34 | 33 | 33 | 33 | 33 | 33 | 33 | 32 | 32 | 32 | 32 | 32 | 32 | 32 |
| 2-TIS | 34 | 34 | 33 | 33 | 33 | 33 | 33 | 33 | 32 | 32 | 32 | 32 | 32 | 32 | 31 | 31 | 31 | 31 | 31 | 31 | 31 |
| 3-TIS | 32 | 32 | 32 | 32 | 32 | 32 | 31 | 31 | 31 | 31 | 31 | 31 | 30 | 30 | 30 | 30 | 30 | 30 | 29 | 29 | 29 |
| 4-TIS | 31 | 31 | 31 | 31 | 31 | 31 | 30 | 30 | 30 | 30 | 30 | 30 | 29 | 29 | 29 | 29 | 29 | 29 | 28 | 28 | 28 |
| 5-TIS | 30 | 30 | 30 | 30 | 30 | 30 | 29 | 29 | 29 | 29 | 29 | 29 | 28 | 28 | 28 | 28 | 28 | 28 | 27 | 27 | 27 |
| 6-TIS | 29 | 29 | 29 | 29 | 29 | 29 | 28 | 28 | 28 | 28 | 28 | 28 | 27 | 27 | 27 | 27 | 27 | 27 | 26 | 26 | 26 |
| 7-TIS | 28 | 28 | 28 | 28 | 28 | 28 | 27 | 27 | 27 | 27 | 27 | 27 | 26 | 26 | 26 | 26 | 26 | 26 | 25 | 25 | 25 |
| 8-TIS | 26 | 26 | 26 | 26 | 26 | 26 | 26 | 25 | 25 | 25 | 25 | 25 | 25 | 25 | 25 | 24 | 24 | 24 | 24 | 24 | 24 |

Table 2: The environment temperature curve of the high temperature setting for heating

| T4 | ≤ -20 | -19 | -18 | -17 | -16 | -15 | -14 | -13 | -12 | -11 | -10 | -9 | -8 | -7 | -6 | -5 | -4 | -3 | -2 | -1 | 0 |
|-------|-------|-----|-----|-----|-----|-----|-----|-----|-----|-----|-----|----|----|----|----|----|----|----|----|------|----|
| 1-TIS | 55 | 55 | 55 | 55 | 54 | 54 | 54 | 54 | 54 | 54 | 54 | 53 | 53 | 53 | 53 | 53 | 53 | 53 | 53 | 53 | 52 |
| 2-TIS | 53 | 53 | 53 | 53 | 52 | 52 | 52 | 52 | 52 | 52 | 52 | 52 | 51 | 51 | 51 | 51 | 51 | 51 | 51 | 51 | 50 |
| 3-TIS | 52 | 52 | 52 | 52 | 51 | 51 | 51 | 51 | 51 | 51 | 51 | 51 | 50 | 50 | 50 | 50 | 50 | 50 | 50 | 50 | 49 |
| 4-TIS | 50 | 50 | 50 | 50 | 49 | 49 | 49 | 49 | 49 | 49 | 49 | 49 | 48 | 48 | 48 | 48 | 48 | 48 | 48 | 48 | 47 |
| 5-TIS | 48 | 48 | 48 | 48 | 47 | 47 | 47 | 47 | 47 | 47 | 47 | 47 | 46 | 46 | 46 | 46 | 46 | 46 | 46 | 46 | 45 |
| 6-TIS | 45 | 45 | 45 | 45 | 44 | 44 | 44 | 44 | 44 | 44 | 44 | 44 | 43 | 43 | 43 | 43 | 43 | 43 | 43 | 43 | 42 |
| 7-TIS | 43 | 43 | 43 | 43 | 42 | 42 | 42 | 42 | 42 | 42 | 42 | 42 | 41 | 41 | 41 | 41 | 41 | 41 | 41 | 41 | 40 |
| 8-TIS | 40 | 40 | 40 | 40 | 39 | 39 | 39 | 39 | 39 | 39 | 39 | 39 | 38 | 38 | 38 | 38 | 38 | 38 | 38 | 38 | 37 |
| T4 | 1 | 2 | 3 | 4 | 5 | 6 | 7 | 8 | 9 | 10 | 11 | 12 | 13 | 14 | 15 | 16 | 17 | 18 | 19 | ≥ 20 | |
| 1-TIS | 52 | 52 | 52 | 52 | 52 | 52 | 52 | 51 | 51 | 51 | 51 | 51 | 51 | 51 | 51 | 50 | 50 | 50 | 50 | 50 | 50 |
| 2-TIS | 50 | 50 | 50 | 50 | 50 | 50 | 50 | 49 | 49 | 49 | 49 | 49 | 49 | 49 | 49 | 48 | 48 | 48 | 48 | 48 | 48 |
| 3-TIS | 49 | 49 | 49 | 49 | 49 | 49 | 49 | 48 | 48 | 48 | 48 | 48 | 48 | 48 | 48 | 47 | 47 | 47 | 47 | 47 | 47 |
| 4-TIS | 47 | 47 | 47 | 47 | 47 | 47 | 47 | 46 | 46 | 46 | 46 | 46 | 46 | 46 | 46 | 45 | 45 | 45 | 45 | 45 | 45 |
| 5-TIS | 45 | 45 | 45 | 45 | 45 | 45 | 45 | 44 | 44 | 44 | 44 | 44 | 44 | 44 | 44 | 43 | 43 | 43 | 43 | 43 | 43 |
| 6-TIS | 42 | 42 | 42 | 42 | 42 | 42 | 42 | 41 | 41 | 41 | 41 | 41 | 41 | 41 | 41 | 40 | 40 | 40 | 40 | 40 | 40 |
| 7-TIS | 40 | 40 | 40 | 40 | 40 | 40 | 40 | 39 | 39 | 39 | 39 | 39 | 39 | 39 | 39 | 39 | 39 | 39 | 39 | 39 | 38 |
| 8-TIS | 37 | 37 | 37 | 37 | 37 | 37 | 37 | 36 | 36 | 36 | 36 | 36 | 36 | 36 | 36 | 35 | 35 | 35 | 35 | 35 | 35 |

The automatic setting curve

The automatic setting curve is the ninth curve, this is the calculation:

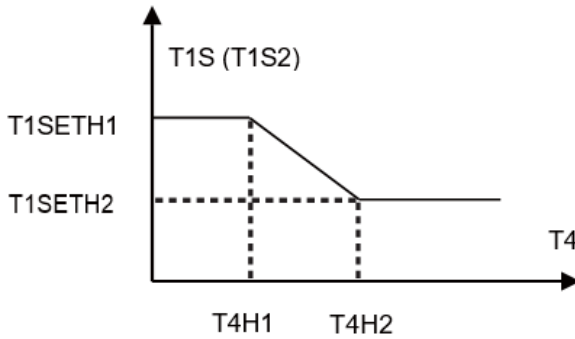

State: In the setting the wired controller, if $T4H2 < T4H1$, then exchange their value; if $T1SETH1 < T1SETH2$, then exchange their value.

Table 3: The environment temperature curve of the low temperature setting for cooling

| T4 | $-10 \leq T4 < 15$ | $15 \leq T4 < 22$ | $22 \leq T4 < 30$ | $30 \leq T4$ |
|--------|--------------------|-------------------|-------------------|--------------|
| 1- T1S | 16 | 11 | 8 | 5 |
| 2- T1S | 17 | 12 | 9 | 6 |
| 3- T1S | 18 | 13 | 10 | 7 |
| 4- T1S | 19 | 14 | 11 | 8 |
| 5- T1S | 20 | 15 | 12 | 9 |
| 6- T1S | 21 | 16 | 13 | 10 |
| 7- T1S | 22 | 17 | 14 | 11 |
| 8- T1S | 23 | 18 | 15 | 12 |

Table 4: The environment temperature curve of the high temperature setting for cooling

| T4 | - 10≤ T4< 15 | 15≤ T4< 22 | 22≤ T4< 30 | 30≤ T4 |
|--------|--------------|------------|------------|--------|
| 1- T1S | 20 | 18 | 17 | 16 |
| 2- T1S | 21 | 19 | 18 | 17 |
| 3- T1S | 22 | 20 | 19 | 17 |
| 4- T1S | 23 | 21 | 19 | 18 |
| 5- T1S | 24 | 21 | 20 | 18 |
| 6- T1S | 24 | 22 | 20 | 19 |
| 7- T1S | 25 | 22 | 21 | 19 |
| 8- T1S | 25 | 23 | 21 | 20 |

The automatic setting curve

The automatic setting curve is the ninth curve, this is the calculation

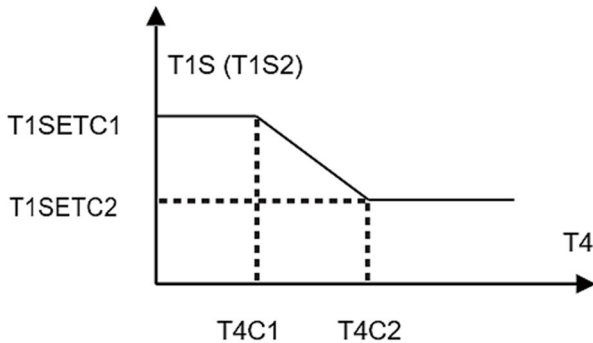

State: In the setting the wired controller, if $T4C2 < T4C1$, then exchange their value; if $T1SETC1 < T1SETC2$, then exchange their value.

DISPOSAL OF ELECTRICAL AND ELECTRONIC EQUIPMENT



To protect our environment and to recycle the raw materials used as completely as possible, the consumer is asked to return unserviceable equipment to the public collection system for electrical and electronic.

The symbol of the crossed indicates that this product must be returned to the collection point for electronic waste to feed it by recycling the best possible raw material recycling.

By ensuring this product you will prevent possible negative effects on the environment and human health, which could otherwise be caused due to improper disposal of that product. The recycling of materials from this product, you will help to preserve a healthy environment and natural resources. For detailed information about the collection of EE products contact the dealer where you purchased the product.

EU DECLARATON OF CONFORMITY

This device is manufactured in accordance with the applicable European standards and in accordance with all applicable Directives and Regulations.



EU declaration of conformity can be downloaded from the following link:
www.msan.hr/dokumentacijaartikala

POŠTOVANI!

Zahvaljujemo na kupnji VIVAX uređaja i nadamo se da ćete biti zadovoljni odabirom. Ako u jamstvenom roku bude potreban popravak proizvoda, molimo savjetujte se sa ovlaštenim prodavačem koji Vam je proizvod prodao ili nas kontaktirajte na dolje navedene brojeve i adrese. MOLIMO VAS DA PRIJE UPORABE PROIZVODA PAŽLJIVO PROČITATE UPUTE PRILOŽENE UZ PROIZVOD!

JAMSTVENI LIST

VIVAX

HR

MODEL UREĐAJA

SERIJSKI BROJ

DATUM PRODAJE

BROJ RAČUNA PRODAVATELJA

POTPIS I PEČAT PRODAVATELJA

| |
|--|
| |
| |
| |
| |
| |

1. Preuzimamo obavezu besplatno popraviti ili zamijeniti neispravne dijelove VIVAX klima uređaja koji bi se takvim pokazali za vrijeme trajanja jamstva, kao greška prilikom izrade ili montaže. Ovim jamstvom jamčimo da će predmet ovog jamstva raditi bez pogreške uzrokovane eventualnom lošom izradom ili lošim materijalom izrade. Svi, eventualno nastali, kvarovi biti će besplatno otklonjeni od strane ovlaštenog servisa u jamstvenom roku.

UVJETI JAMSTVA:

2. Jamstveni rok počinje od dana kupnje proizvoda i traje **24 mjeseca**, osim modela **ACP-xxxxCCxxxxx, ACP-xxxxCTxxxxx, ACP-xxxxDTxxxxx, ACP-xxxxCFxxxxx, ACP-xxxxFSxxxxx** za koje vrijedi jamstvo u trajanju od **12 mjeseci**
3. **Jamstvo na uređaje u upotrebi produžuje se za sljedećih 12 mjeseci nakon izvršenja jamstvenog servisnog pregleda od strane ovlaštenog servisa.**
4. **Jamstvo se može produljivati ukupno tri puta, osim modela ACP-xxxxCCxxxxx, ACP-xxxxCTxxxxx, ACP-xxxxDTxxxxx, ACP-xxxxCFxxxxx, ACP-xxxxFSxxxxx za koje se jamstvo može produljivati četiri puta, što u ukupnom trajanju može iznositi maksimalno 60 mjeseci**
5. Jamstveni servisni pregled naplaćuje ovlašteni servis po cjeniku zastupnika M SAN Grupa d.o.o. i ovjerava jamstveni list što dokazuje produljenje i valjanost jamstva.
6. Jamstvo vrijedi ako su montaža ili servis VIVAX klima uređaja obavljani od strane ovlaštenog servisa kojeg je ovlastio zastupnik M SAN Grupa d.o.o.
7. VIVAX klima uređaj kao cjelinu čine jedna ili više unutarnjih jedinica, instalacija i vanjska jedinica koje su pravilno odabrani i koji si međusobno odgovaraju po modelu i snazi.
8. U slučaju kvara na proizvodu koji je predmet ovog jamstva, obvezujemo se da ćemo isti popraviti u najkraćem mogućem roku, a najkasnije u roku od 45 dana. Ako se proizvod ne može popraviti ili se ne popravi u roku od 45 dana, biti će zamijenjen novim. Jamstvo će biti produljeno za vrijeme trajanja popravka.
9. Jamstvo se priznaje samo uz račun o kupnji, te uz ovaj jamstveni list koji mora biti ispravno popunjen odnosno mora sadržavati datum prodaje, pečat i potpis prodavatelja, ovlaštenog montažera ili servisera.
10. Davalac jamstva osigurava servis i rezervne dijelove 5 godina od datuma kupnje VIVAX klima uređaja

JAMSTVO NE OBUHVAĆA:

11. Redovnu provjeru, održavanje uz zamjenu dijelova koji se troše normalnom upotrebom, prilagođavanje ili promjene za poboljšanje proizvoda za primjenu koji nisu opisane u tehničkim uputama za korištenje, osim ako je za te preinake predočena suglasnost M SAN GRUPA d.o.o.
12. **Jamstvo se ne priznaje u sljedećim slučajevima:**

Ako kupac ne predoči ispravan jamstveni list i račun o kupnji.
Ako se kupac nije pridržavao uputa o korištenju proizvoda.
Ako je proizvod otvaran, prepravljani ili popravljan od neovlaštene osobe.
Ako su kvarovi na proizvodu nastali djelovanjem više sile kao što su: udar groma, strujni udari u električnoj mreži elementarne nepogode i slično.
Ako su kvarovi nastali oštećenjem zbog nepropisane upotrebe ili nepravilnim transportiranjem. Ako je kvar nastao pogreškom u sustavu na koji je proizvod priključen.
Montažom, servisnim pregledom ili popravkom VIVAX klima uređaja **od strane neovlaštenog servisa**, radionice ili treće osobe, kupac VIVAX klima uređaja gubi pravo na jamstvo.
Ovim jamstvom nisu obuhvaćene neispravnosti koje bi nastale zbog nepažljivog ili nestručnog rukovanja, zbog nepoštivanja uputa proizvođača za rukovanje tj. zbog bilo koje okolnosti koja se ne može pripisati grešci izrade uređaja
Ovo jamstvo vrijedi samo za robu kupljenu u Republici Hrvatskoj u odnosu na ona koja propisuje proizvođač.
Iz jamstva je isključena odgovornost za eventualne ozljede koje bi mogle pretrpjeti osobe ili životinje, odnosno na bilo koje štete nastale funkcioniranjem ili nefunkcioniranjem uređaja
Jamstveni kuponi služe za pravljanje popravaka uređaja
Prilikom popravka servis ima pravo zadržati jedan jamstveni kupon
13. Izjava o sukladnosti i presliku izvorne Izjave sukladnosti (EU Declaration of Conformity) možete jednostavno preuzeti na našoj internetskoj stranici www.msan.hr/dokumentacijaartikala

Naziv tvrtke davatelja jamstva: M SAN GRUPA d.o.o., Buzinski prilaz 10,10010 Zagreb-Buzin, tel: 01/3654-961
 CENTRALNI SERVIS: MR servis d.o.o, Dugoselska cesta 5,10370 Rugvica
 Tel: +385 1 640 1111 Fax: +385 1 365 4982 E-mail za opće upite: info@mrsevis.hr,
 E-mail za prodajne upite: prodaja@mrsevis.hr, Web: www.mrsevis.hr

| | | |
|-----------------------------|--|--|
| DATUM SERVISNE INTERVENCIJE | | |
| DATUM POPRAVKA | | |
| DATUM SERVISNE INTERVENCIJE | | |
| DATUM POPRAVKA | | |
| DATUM SERVISNE INTERVENCIJE | | |
| DATUM POPRAVKA | | |

Ugradnja

| DATUM UGRADNJE | OVLAŠTENI SERVIS I POTPIS |
|----------------|---------------------------|
| | |

Servisni periodični pregled i održavanje:

| | |
|----------------------------|--------------------------|
| Servisni pregled 1 | Ovlašteni servis: |
| Datum: | |
| Vrijedi do: | |
| Servisni pregled 2 | Ovlašteni servis: |
| Datum: | |
| Vrijedi do: | |
| Servisni pregled 3 | Ovlašteni servis: |
| Datum: | |
| Vrijedi do: | |
| Servisni pregled 4* | Ovlašteni servis: |
| Datum: | |
| Vrijedi do: | |

* Servisni pregled 4 vrijedi samo za modele s osnovnim jamstvom od 12 mjeseci

| Grad | Servis | Adresa | Telefon |
|---------------------|------------------------------------|---------------------------|--------------|
| Bjelovar | Koda d.o.o. | Vladimira Nazora 14 | 043/225 245 |
| Bjelovar | Begić d.o.o. | Male Sredice 47 b | 095/903-0860 |
| Buje-Oprtalj | Elektro servis Šorgo | Šorgi 6 | 091/424-2958 |
| Cavtat | Šturica-obrt za | Gornji Obod 31 | 098/345-026 |
| Cerna | Elektroinst, i klimatizacija Sabo | Josipa Kozarca 70 | 097/704-6424 |
| Čavle-Rijeka | Termo servis Čargonja d.o.o. | Buzdohanj 36 | 098/366-499 |
| Čavle-Rijeka | Optimare d.o.o. | Zastenice 52 | 095/2222-312 |
| Čazma | VI. Tihomir Vreš Serv. Kuć. ap. ČA | F.Vidović 35 | 043/771-924 |
| Daruvar | Stilios d.o.o. | Trg dr.Franje Tuđmana 3 | 099/3719-084 |
| Donja Bistra-Zagreb | Servis Borovec | Pljuskovec 4 | 098/212-783 |
| Donja Pušća | Klimatizacija Ljubić j.d.o.o. | Voćarska 6a | 099/3315-504 |
| Donji Miholjac | Elektronik centar Menges | Kolodvorska 47 | 031/632-640 |
| Dubrovnik | Tehno Elektronik d.o.o. | Josipa Kosora 46 | 091/2437-750 |
| Dubrovnik | Radan Elektronik Centar d.o.o. | Obala Pape Ivana Pavla II | 020/418-500 |
| Dubrovnik | Barović Best d.o.o. | Nikole Tesle 16 | 020/356-199 |
| Dubrovnik | Frigus servis d.o.o. | Kneza Branimira 19 | 020/424-669 |
| Dugi Rat | Obrt za usluge Mušac | Glavica 4 | 091/7639-198 |
| Dugo Selo | Servis Dado d.o.o. | Kolodvorska 26 | 098/286-286 |
| Imotski | K-M d.o.o. | Brune Bušića 13 | 021/841-316 |
| Imotski | T.U.O. Procesor | Brune Bušića 20 | 095/270-1973 |
| Kaptol | Servis Jelušić | Požeška 40 | 099/362-6852 |
| Karlovac | Čulig d.o.o. | Miroslava Krleže 2 | 098/364-524 |
| Kaštela | Parchy obrt | Ivana Danila 7 | 098/823-171 |
| Kaštelir | Klima Instal j.d.o.o. | Dvori 9 | 099/7306-363 |
| Knin | Elektro servis Vujević | Tvrtkova 1 | 098/818-991 |
| Konščani | Hlađenje-Kucelj j.d.o.o. | Konščani 26 | 098/723-223 |
| Koprivnica | GTK d.o.o. | Franje Gažija 3 | 048/622-754 |
| Krapina | Zvonček | Gajeva 28 | 049/370-990 |
| Križevci | Elektro Babić-servis | Zagorska 86 | 048/714-219 |
| KRK | Obrt Elektroservis MI | Kras 145a | 051/266-193 |
| Kutina | SF klima, grijanje | A.Mihanovića 25 | 098/730-650 |
| Lipik | Zandona servis | Tabor 53 | 098/9534-871 |
| Makarska | Tarčuki obrt | Obala kralja Tomislava 13 | 098/195-7246 |
| Makarska | Kingtrade d.o.o. | Dubrovačka 29 | 021/679-407 |
| Makarska | Obrt za P.E.A. i T. Pašketo | A. Starčevića 26 | 021/611-850 |
| Metković | Alterm | Zagrebačka 46 | 095/889-3333 |
| Metković | Finel d.o.o. | Mostarska 10a | 020/690-730 |
| Mundanije | Instalaterski obrt – Rab | Mundanije 212 | 098/190-3427 |
| Našice | Servis kućanskih aparata Elkon | Trg I. Kršnjavog | 031/615-090 |
| Nova Gradiška | Friigo | Strossmayerova 18 | 035/362-299 |
| Novska | Senior & Junior | I.Meštrovića 11 | 044/601-601 |

| | | | |
|----------------|------------------------------------|----------------------------|---------------|
| Ogulin | Electrico VI. Zdravko Miloš | Podvrh III/10 | 047/525-777 |
| Ogulin | Bubi , obrt za elektroinst. radove | Cvijetna 3 | 099/700-8001 |
| Ogulin | Elektrotrade Ogulin | Dražice 55 | 047/525-972 |
| Osijek | Impuls d.o.o., Josipovac | Matije Gupca 36b | 091/254-8118 |
| Osijek | Frigo-dom obrt | Alanska 33 | 098/1949-722 |
| Petrača | Bio Bor d.o.o. | Baletići 9 | 091/661-1159 |
| Petrinja | Imela j.d.o.o. | Otona Kučere 24 | 099/8086-165 |
| Pitomača | Probox j.d.o.o. | Dragutina Domjanića 11a | 098/377-029 |
| Pleternica | Elektroservis Čirko | M.Budaka 38 | 034/251-666 |
| Ploče | Amadeus II d.o.o. | Vladimira Nazora 45 | 020/670-111 |
| Ploče | Elektroinst. Četvrta, vl. M.Budiša | V. Nazora 23 | |
| Pojatno | Microservis d.o.o. | Cvijetna 2 | 01/3392-200 |
| Poreč | Frigoservis Šime | Kadumi 22 | 091/500-4242 |
| Poreč | Labelle d.o.o. | Creska 34 | 052/453-052 |
| Pula | Klima Sistem d.o.o. | Gladijatorska 29 | 091/136-7063 |
| Pula | Eko klima-instalacije | Argonautska 67 | 052/381-050 |
| Pula | Bolles-Istrafrigo d.o.o. | De Franceschijeva 29 | 052/392 099 |
| Rab | Elektromeh. servis Pino | Banjol 88 | 098/369-672 |
| Rijeka | Termo servis Čargonja d.o.o. | Buzdohanj 36 | 098/366-499 |
| Rijeka | K. Arsen d.o.o. | Put Lovranki 15 | 098/791-814 |
| Samobor | Elektro servis Husta | Voćarska 2,Samoborski otok | 095/906-0012 |
| Sesvete | Elko Tronik j.d.o.o. | Kašinska 27f | 098/844-994 |
| Sisak | GEK j.d.o.o. | Mljetska 8 | 095/851-6368 |
| Sisak | ETC Sisak d.o.o. | 22 lipnja 4f | 044/549-500 |
| Sisak | Servis kućanskih ap. Kramarić | Ante Starčevića 27 | 044/549-119 |
| Slavonski Brod | Tempus d.o.o. | Baranjska 9 | 091/2504-170 |
| Slavonski Brod | Klimatronic | K.Frankopana 4 | 095/8463-314 |
| Solin | Obrt FIGO, vl.Jozo Ninčević | Šubićeva 8 | 091/532-02-65 |
| Solin | Advena d.o.o. | Kaštelanska 8 | 098/661-661 |
| Solin | Klimatronik j.d.o.o. | Put mira 43/a | |
| Split | Mitella d.o.o. | Vinogradska 74 | 091/645-66 44 |
| Split | Periš- trgovina, servis | Stepinčeva 8 | 021/539-209 |
| Split | Klima Vučković d.o.o. | R.Boškovića 23 | 091/251-7085 |
| Šibenik | Elektro-AB vl.Ante Bura | Svilajska 32 | 091/215-4115 |
| Šibenik | Frigo Bešić j.d.o.o. | Put kroz Meterize 43 | 099/437-8444 |
| Šibenik | Tehno Jelčić d.o.o. | Sarajevska 9 | 022/217-264 |
| Šibenik | Klimaexpert KVR obrt vl.Š.Gurlica | 8. Udarne dalmatinske | 098/961-5326 |
| Šibenik | Klima Elektro Šupe | Ivana Meštrovića 13 | 099/4378-286 |
| Trilj -Sinj | Pešo d.o.o. | Dubrovačka 1 | 021/660-162 |
| Varaždin | Servis BI-EL vl. Zdravko Keliš | Primorska 20 | 042/350-765 |
| Varaždin | Termo Tim d.o.o. | Cerje tužno 32 | 098/1948-250 |
| Varaždin | Elektromeh. obrt Marković | K. Fi lića 9 | 042/210-588 |
| Vela luka | Piccolo, vl. Goran Šego | Ulica 41 br 15 | 020/813-218 |
| Vela Luka | Obrt Elektro-servis Bage | Obala 3 | 020/813-564 |
| Velika Gorica | Elektro servis i trg. Meštrović | Slavka Kolara 10 | 01/6222-622 |

| | | | |
|----------------|-------------------------------------|-------------------------------|--------------|
| Vinkovci | Obrt Corect vl.Davor Turalija | Ante Starčevića 54 | 098/358-458 |
| Virovitica | Fruk d.o.o. | Strossmayerova 9 | 098/403-631 |
| Viškovo-Rijeka | Kjukur d.o.o. | Gornji Sroki 141 | 098/327-146 |
| Vukovar | Servis Jagetić , Elektromeh. obrt | Radnička 63 | 091/560-0474 |
| Zadar | I-Klima | Domovinskog rata 8 | 091/508-0960 |
| Zadar | Arija-Nova d.o.o. | Ulica braće Miroslava i Janka | 023/316-060 |
| Zadar | T.O. Optima | Kneza Novaka Krbavskog 42 | 023/241-801 |
| Zadar | Štefančić-inst. Klima uređ i centr. | Splitska 42 a | 097/679-0769 |
| Zadar | Montis trg. instalaterski obrt | Put Vukića 1 | 023/384-138 |
| Zadar | Vedran Company d.o.o. | Nikole Tesle 18 | 095/123-0000 |
| Zadvarje | Instalacije Jerčić | Šupukova glavica 12 | 092/292-2225 |
| Zagreb | Pušić d.o.o. | Vodnjanska 26 | 01/3028-226 |
| Zagreb | Tami projekt d.o.o. | Dubrava 3 | 098/9838-500 |
| Zagreb | Burić-Klima d.o.o. | Jurja Ves 2, Odvojak 8 | 01/234-2555 |
| Zagreb | Klima Buhin vl. Franjo Buhin | Maksimirska 11 | 099/3762-483 |
| Zagreb | Klima Zirdum d.o.o. | Sv.Nikole Tavelića 33 | 098/626-666 |
| Zagreb | Centar klima d.o.o. | 10 podbrežje 14 | 091/578-5943 |
| Zagreb-Dubrava | Pamajo d.o.o. | Vranička 7 a | 01/294-5113 |
| Županja | Ancol Obrtnička radnja | Kratka 20 | 098/636-286 |

POŠTOVANI!

Zahvaljujemo Vam na kupovini Vivax proizvoda i nadamo se da ćete biti zadovoljni izborom.

MOLIMO VAS DA PRE UPOTREBE PROIZVODA PAŽLIVO PROČITATE TEHNIČKU DOKUMENTACIJU I DA SE PRILIKOM UPOTREBE PRIDRŽAVATE PRILOŽENIH UPUTSTAVA

GARANTNI LIST 24+36=60 MESECI

VIVAX

SR

OSNOVNI PODACI O PROIZVODU (Popunjava trgovac)

| | |
|---------------------------------------|--|
| MODEL UREĐAJA | |
| SERIJSKI BROJ | |
| DATUM PRODAJE | |
| BROJ RAČUNA / FISKALNOG ISEČKA | |
| POTPIS I PEČAT TRGOVCA | |

U skladu sa članom 49 Zakona o zaštiti potrošača roba je saobrazna ako:

- odgovara opisu koji je dao prodavac i ako ima svojstva robe koju je prodavac pokazao potrošaču kao uzorak ili model,
- ima svojstva potrebna za naročitu upotrebu za koju je potrošač nabavlja, a koja je bila poznata prodavcu ili mu je morala biti poznata u vreme zaključenja ugovora,
- ako ima svojstva potrebna za redovnu upotrebu robe iste vrste,
- po kvalitetu i funkcionisanju odgovara onome što je uobičajeno kod robe iste vrste i što potrošač može osnovano da očekuje s obzirom na prirodu robe i javna obećanja o posebnim svojstvima robe data od strane prodavca, proizvođača ili njihovih predstavnika, naročito ako je obećanje učinjeno putem oglasa ili na ambalaži robe.

Ako isporučena roba nije saobrazna ugovoru (član 51 Zakona o zaštiti potrošača), potrošač ima pravo da zahteva od prodavca da otkloni nesaobraznost, bez naknade, opravkom ili zamenom, odnosno da zahteva odgovarajuće umanjenje cene ili da raskine ugovor u pogledu te robe.

Potrošač, na prvom mestu, može da bira između zahteva da se nesaobraznost otkloni opravkom ili zamenom.

Ako otklanjanje nesaobraznosti u skladu sa stavom 2. ovog člana, nije moguće ili ako predstavlja nesrazmerno opterećenje za trgovca, potrošač može da zahteva umanjenje cene ili da izjavi da raskida ugovor.

Nesrazmerno opterećenje za trgovca u smislu stava 3. ovog člana, javlja se ako u poređenju sa umanjenjem cene i raskidom ugovora, stvara preterane troškove, uzimajući u obzir:

1. vrednost robe koju bi imala da je saobrazna ugovoru;
2. značaj saobraznosti u konkretnom slučaju;
3. da li se saobraznost može otkloniti bez značajnijih neugodnosti za potrošača.

Svaka opravka ili zamena se mora izvršiti u primerenom roku i bez značajnijih neugodnosti za potrošača, uzimajući u obzir prirodu robe i svrhu zbog koje ju je potrošač nabavio.

Sve troškove koji su neophodni da bi se roba saobrazila ugovoru, a naročito troškovi rada, materijala, preuzimanja i isporuke, snosi trgovac.

Potrošač ima pravo da raskine ugovor, ako ne može da ostvari pravo na opravku ili zamenu, odnosno ako trgovac nije izvršio opravku ili zamenu u primerenom roku ili ako trgovac nije izvršio opravku ili zamenu bez značajnijih nepogodnosti za potrošača.

Potrošač ne može da raskine ugovor ako je nesaobraznost robe neznatna. Prava navedena u stavu 1. ovog člana, ne utiču na pravo potrošača da zahteva od trgovca naknadu štete koja potiče od nesaobraznosti, u skladu sa opštim pravilima o odgovornosti za štetu.

Ova garancija ne isključuje i ne utiče na prava koja Vi kao potrošač imate na osnovu Zakona o zaštiti potrošača i koja ostvarujete u vezi sa saobraznošću robe u roku od 24 meseca od kupovine ovog uređaja.

Ova izjava garantuje da će proizvod i po isteku roka saobraznosti od 2 godine shodno Zakonu o zaštiti potrošača, u dodatnom periodu od 36 meseci ispravno funkcionisati pod uslovima predviđenim ovim garantnim listom.

Davalac garancije:

KIM-TEC d.o.o. Beograd, Viline vode bb, Slobodna zona Beograd L12/3, MB 17586491

Uvoznik i distributer: KIM-TEC d.o.o. Beograd, MB 17586491

**Viline Vode bb, Slobodna zona Beograd L12/3
Beograd**

Dužina trajanja garancije i teritorija: Garancija važi na teritoriji Republike Srbije.

24 + 36 = 60 meseci

***2 godine zakonske saobraznosti + 3 godina dodatne garancije**

SADRŽINA GARANCIJE, USLOVI I POSTUPAK OSTVARIVANJA PRAVA IZ GARANCIJE

KIM-TEC D.O.O garantuje da će proizvod u garantnom roku pravilno funkcionisati, ako njime budete rukovali prema priloženom uputstvu i u granicama izdržljivosti koje propisuje proizvođač.

Garancija i garantni rok počinju teći, istekom roka od 2 godine (24 meseca) zakonske saobraznosti i traje 36 meseci. Prava iz garancije ostvarujete prilaganjem overenog i popunjenog garantnog lista.

KIM-TEC D.O.O se obavezuje da će na Vaš zahtev, izražen u garantnom roku, otkloniti u svojim, odnosno ugovorenim servisnim odeljenjima, kvarove i tehničke nedostatke proizvoda koji su nastali prilikom normalne upotrebe, u vremenu za koje se garancija daje.

Ukoliko kvar ili nedostaci ne budu otklonjeni u roku od 45 dana od dana prijema uređaja od korisnika, KIM-TEC D.O.O. kao davalac garancije se obavezuje da će neispravni uređaj zameniti istim takvim ispravnim ili uređajem sličnih karakteristika.

KIM-TEC D.O.O se obavezuje da će obezbediti servis uređaja u ukupnom roku od 60 meseci od dana kupovine (24 meseca u skladu sa Zakonom o zaštiti potrošača+36 meseci u skladu sa ovom garancijom).

U garanciju ne ulaze oštećenja prouzrokovana prilikom transporta nakon isporuke, oštećenja zbog nepravilne montaže ili održavanja, korišćenja neodgovarajućeg potrošnog materijala (prema propisanom) mehanička oštećenja nastala krivicom korisnika, oštećenja zbog varijacije napona električne mreže, udara groma i pratećih pojava.

U garanciju ne spadaju delovi koji se troše i to: daljinski upravljač i baterije

OBAVEZE KORISNIKA

1. Da se pridržava uslova garancije i da se pre prve upotrebe uređaja upozna sa uslovima ove garancije i tehničkom dokumentacijom.
2. Da se eksploatacija uređaja vrši u skladu sa uputstvima navedenim u pripadajućoj tehničkoj dokumentaciji.
3. Da obezbedi stabilan izvor mrežnog napajanja (varijacije napona max. 10%, varijacije učestanosti max. 30%).
4. Da obezbedi uzemljenu elektroinstalaciju kako bi se izbegle razlike potencijala.
5. Da po mogućnosti sačuva svu priloženu tehničku dokumentaciju.

IZJAVA DAVAOKA GARANCIJE

1. Proizvodi imaju propisane, odnosno deklarirane karakteristike kvaliteta. Davalac garancije, u garantnom roku, o svom trošku osigurava otklanjanje kvarova i nedostataka proizvoda koji proizilaze iz nepodudarnosti stvarnih sa propisanim, odnosno deklariranim karakteristikama kvaliteta proizvoda. U slučaju neizvršenja ove obaveze davalac garancije će izvršiti poravku ili zameniti proizvod novim istim ili sličnih karakteristika ili omogućiti kupcu povrat novca preko prodavca kod koga je uređaj kupljen.
2. Proizvod će u garantnom roku ispravno funkcionisati ako se primenjuju data tehnička uputstva. Davalac garancije se obavezuje da će besplatno otkloniti kvarove i nedostatke u ovlašćenom servisu, zbog kojih proizvod ne funkcioniše ispravno.
3. Vlasnik aparata dužan je da vodi računa o ispravnoj veri garantnog lista bez čega garantni list ne važi, kao i da čuva potvrde o izvršenom redovnom servisu uređaja od strane ovlašćenog servisa za VIVAX klima uređaje.
4. Rok obezbeđenog servisiranja proizvoda je 60 meseci od dana kupovine (24 meseca u skladu sa Zakonom o zaštiti potrošača+36 meseci u skladu sa ovom garancijom).

USLOVI GARANCIJE

1. Da je klima uređaj montiran u kućnim i kancelarijskim uslovima po uputstvu i predviđenim standardima od strane ovlašćenog servisa VIVAX klima uređaja;
2. Da se klima uređaj koristi u skladu sa korisničkim uputstvom;
3. **Da se vrši redovan godišnji servis klima uređaja na kraju druge, treće i četvrtne godine od datuma kupovine klima uređaja.** Redovan servis mora obaviti ovlašćeni serviser za VIVAX klima uređaje. **Troškove redovnog godišnjeg servisa snosi korisnik uređaja.**
4. **Potrošač je u obavezni da instalaciju/ servis poveri isključivo ovlašćenom serviseru za VIVAX klima uređaje,** kao i da ne ošteti kontrolnu nalepnicu.

Petogodišnja garancija nije prenosiva na druge VIVAX proizvode, već se odnosi isključivo na registrovane (prijavljene) klima uređaje. Garantni rok počinje istekom roka saobraznosti od 2 godine u skladu sa Zakonom o zaštiti potrošača i traje 36 meseci pod gore navedenim uslovima.

POSTUPAK OSTVARIVANJA PRAVA IZ GARANCIJE

Prava iz garancije ostvarujete kontaktiranjem ovlašćenog servisa za Vivax klima uređaje i prilaganjem overenog i popunjenog garantnog lista, dokaza o kupovini, dokaza o ugradnji klima uređaja od strane ovlašćenog servisa kao i dokaza o obavljenom redovnom servisu klime na kraju druge, treće i četvrtne godine.

Kupac gubi pravo na garanciju:

- ako se kvar izazove nepridržavanjem datih uputstava za upotrebu,
- ako su kvarovi na proizvodu nastali kao posledica neodržavanja uređaja ili usled mehaničkog oštećenja
- ako su na proizvodu vršene bilo kakve popravke od strane neovlašćenih lica,
- ako instalacija nije urađena u skladu sa propisanim tehničkim uslovima,
- ako je korisnik nestručno, neadekvatno koristi i nemarno se ophodi prema klima uređaju,
- ako je proizvod pretrpeo strujni udar ili udar groma,
- ako nije ispunjen bilo koji od gore navedenih USLOVA GARANCIJE

VAŽNE NAPOMENE

1. Pre uključivanja aparata pročitajte uputstvo koje je priloženo uz svaki aparat. Pre nego što se obratite za tehničku pomoć nekom od naših ovlašćenih servisa, molimo Vas da proverite da li su obezbeđeni svi potrebni uslovi za normalan rad aparata.
2. U slučaju opravke, garantni rok će se produžiti onoliko koliko je kupac bio lišen upotrebe stvari.

Sve popravke aparata obavljaju se isključivo u ovlašćenim servisima. Spisak se nalazi na kraju ovog dokumenta

| | | |
|--|--|--|
| DATUM PRIJEMA UREĐAJA NA SERVIS | | |
| DATUM POPRAVKE | | |
| DATUM PRIJEMA UREĐAJA NA SERVIS | | |
| DATUM POPRAVKE | | |
| DATUM PRIJEMA UREĐAJA NA SERVIS | | |
| DATUM POPRAVKA | | |

Ugradnja

| DATUM UGRADNJE | OVLAŠĆENI SERVIS I POTPIS |
|-----------------------|----------------------------------|
| | |

Servisni periodični pregled i održavanje:

| | |
|---------------------------|--------------------------|
| Servisni pregled 1 | Ovlašćeni servis: |
| Datum: | |
| Vrijedi do: | |
| Servisni pregled 2 | Ovlašćeni servis: |
| Datum: | |
| Vrijedi do: | |
| Servisni pregled 3 | Ovlašćeni servis: |
| Datum: | |
| Vrijedi do: | |

5 godina garancije - 2 godine zakonske saobraznosti plus 3 godine uz redovan godišnji servis

Centralni servis: KIM-TEC d.o.o., Viline vode bb, Slob. zona Bg, Beograd
Tel: 011/33 13 568 E-mail: servis@kimtec.rs

| Mesto | Servis | Adresa | Telefon |
|----------------|-------------------------------|------------------------|------------------------------|
| Ada | ELEKTROSERVIS UNIEL | Branka Radičevića 51/C | 063/547-939 |
| Aleksandrovac | AZA KOM | 29 Novenbar 17 | 037/751-338 063/692-082 |
| Aleksinac | SKY | Knjaza Miloša 86/4 | 018/805-577 063/402-936 |
| Alibunar | MONT EL ALIBUNAR | Žarka Zrenjanina 6/4 | 063/325-838 |
| Apatin | KRNJAIĆ TIM | Lađarska 87 | 064/2382-817 |
| Arandelovac | MB ELECTRONIC | Kralja Petra I bb | 034/701-235 062/701-235 |
| Arandelovac | MIRKO ANIČIĆ PR PEGAS | Orašački put 291 | 065/2003-180 |
| Arandelovac | TEHNOMONT | Bukuljska 18 | 034/6712-902 0637070628 |
| Arilje | L-MIRČETIĆ | Vojvode Mišića 8 | 063/567-911 |
| Azanja | UR NEŠA HAUZ | Svetog Save 38 | 061/6447-123 |
| Batočina | MATIX 2019 | Kralja Petra Prvog 34 | 060/4031-300 063/515-562 |
| Bač | KLIMA BUGI | Proleterska 26 | 021/6047-054 064-6154-750 |
| Bačka palanka | BAP ELEKTRO d.o.o. | Branka Radičevića 27 | 021/754-093 063/580-905 |
| Bačka palanka | TIM KONTAKT | Branka Radičevića 121 | 021/753-286 062/206-344 |
| Bačka topola | ELEKTROMONT-BŽ | Košut Lajoša 59 | 024/716-320 060/3139-565 |
| Bačka topola | K&K ELEKTRO | Lenjinova 75 | 069-1070-411 |
| Bačka topola | SMARTCOM | 1.maja 2 | 024/711-373 063/8862-634 |
| Bački petrovac | SZR BELI PRIJATELJ | Karla Marksa 2 | 063/8569-198 |
| Bačevac | FRIGO M | Beog.Bataljona 18 | 011/8300-655 065/8300-655 |
| Bečej | AS IMPEX ELEKTROSERVIS | Miloša Crnjanskog 11a | 063/1104-108 |
| Bečej | G2 SERVIS | Holo Ferencza 70 | 021/6910-505 063/8363-776 |
| Bečej | POLARCOOL | Udarnička 53 | 063/8260-854 |
| Bečej | SZTR EL-BO SERVIS | Idjoski put 41 | 021/6915-867 063/8625-904 |
| Bela crkva | MIG COMPUTERS | 1.oktobra 58 | 013/852-501 063/1094-944 |
| Bela crkva | MOBIL & PRO SERVIS I TRGOVINA | 1. oktobra 67 | 013/853-999 062/283-393 |
| Bela crkva | NELE NN BELA CRKVA | Dositejeva 98 | 061/1730-946 |
| Bela crkva | PC SHOP | 1 oktobra 79 | 013/854-273 064/0090-488 |

| | | | |
|---------|------------------------------|--|---|
| Beočin | SOFTEL | Dositeja Obradovića 15 | 021/872-858 063/527-174 |
| Beograd | ACRO KLIMA d.o.o. | Lole Ribara 2 | 011/2578-281 061/1607-416 |
| Beograd | ACS SHOP SERVICE | Zrenjaninski put 5 | 011/2717-181 |
| Beograd | AS FRIGO | Nikole Tesle 11, Leštane | 011/8035-096 064/1170-432 |
| Beograd | ASTRA FRIGO | Gandijeva 60/55 | 011/7179-046 063/283 290 |
| Beograd | BUILCON TIM | Marka Čelebonovića 48 | 011/2169-304 063/8060-587 |
| Beograd | BULEVAR | Bulevar kralja Aleksandra488a lokal30 | 063/835-125 |
| Beograd | COOL4YOU | Marka Cara 16 | 060/7517-707 064/0307-006 |
| Beograd | COOL SHOP | Voždovački kružni 125 | 064/8005-300 |
| Beograd | DELTA ELECTRONIC SZR | Milentija Popovića bb | 011/4094-481 064/1255-442 |
| Beograd | DUMIL FRIGO | Braće Jerkovića 127 | 065/2830-746 |
| Beograd | ELECTRONICS ART | 7.jula7 | 011/8035-514 063/8280-480 |
| Beograd | ENERGOMONT+ | Stevana Filipovića 122/a | 062/200-056 |
| Beograd | FRIGO BEST DOO BEOGRAD | Tome Rosandića 34 | 011/3046-417 063/256-058 064/1329-896 |
| Beograd | FRIGO MAKS | Bore Radojevića 24 | 011/2573-175 064/1101-900 |
| Beograd | FRIGO MV | Dr.Milivoja Babića 26 | 063/1872-538 |
| Beograd | FRIGO-KLIMA | Petra Konjevića 12v lokal 30 | 011/3511-590 064/6424-080 |
| Beograd | FULL HOUSE | Milutina Ivkovića 2 | 062/252-269 069/660-007 |
| Beograd | HOME COOL SYSTEM | Gospićka 21 | 011/6301-170 061/6854-120 |
| Beograd | INPULS TIM | Vinogradi 13 | 011/2589-058 064/1102-730 |
| Beograd | KLIMA TEHNIKA | Požeška 37 | 011/3058-825 |
| Beograd | MAXIMUS | Vodovodska 183 | 011/2580-712 064/2668-909 |
| Beograd | MV FRIGO | Jurija Gagarina 237 | 011/2152-942 064/2478-782 |
| Beograd | OZIRIS ELEKTRIK d.o.o. | Narodnog fronta 78 | 011/3612-377 063/228-044 |
| Beograd | SANTERMO d.o.o. | Tiše kaclerovića 27 z | 060/4476-997 |
| Beograd | SAMSARA d.o.o. | Ruzveltova 1 , lokal 16 | 011/3370-250 065/3370-250 |
| Beograd | SERVIS BELE TEHNIKE ŠINKO | Pinkijeva 1a | 011/2615-619 063/8475-026 |
| Beograd | SMN FRIGO PLUS d.o.o. | Crvenih hrastova 8 | 011/2647-577 063/1106-288 |
| Beograd | TERMO COOL | Generala Ljubomira Milića 10 | 063/622-151 |
| Beograd | TERMOBOSS | Mladena Mitrića 16 | 064/2729-888 |

| | | | |
|------------------|-----------------------------------|------------------------------|---|
| Beograd | TERMOCOOL | Ljubomira Milića 10,1 sprat | 063/622-151 |
| Beograd | VELEMAJSTOR | Bul.Kralja aleksandra | 064/1110-046 |
| Beograd | Z.R.ALSTEDO | Put za Ovču 20g | 011/3329-719 |
| Bogatić | ELEKTROSERVIS SRDANOVIĆ | Pavla Orlovića 105a | 015/7413-501 060/7413-501 |
| Bogatić | ENERGY SZTKR | Mike Vitomirovića 14 | 015/7786-434 060/558-67-44; 064/258-67-44 |
| Bor | ELEKTRON SC | Treći Oktobar 39b | 030/427-031 061/7154-178 |
| Bor | SERVIS TERZIĆ DEJAN | Njegoševa 46 | 030/423-360 063-11 79 031 |
| Borča | PR ZANATSKA RADNJA ALSTEDO | Put za Ovču 20/G | 063-773-9041 |
| Crvenka | CRVENKA NET | Petra Drapšina 7 | 025/731-167 069/731-167 |
| Čačak | DMG ELEKTRO | Stevana Prvovenčanog 49 | 032/332-507 060/586-933 |
| Čačak | ELEKTROLINK d.o.o. | Bul. Tanaska Rajića 66 | 032/345-100 064/8403-569 |
| Čačak | ELCOOL KLIMATIZACIJA | Ćurčić Milete 16 | 064/6686-474 |
| Čačak | S.Z.R. FRIGO - M PLUS | Svetog Save 7/2 | 064/1368-646 |
| Čačak | USPON DOO | Gradsko šetalište 57 | 032/340-410 064/8601-500 |
| Ćičevac | PC TECH | Karađorđeva 241 | 037/813-303 063/638-329 |
| Ćuprija | EUROMONT | Jugoslovenska 16 | 063/667-252 |
| Ćuprija | NBN ELEKTRO | Sretena Zdravkovića 114 | 063/640-361 |
| Ćuprija | VPN RAČUNARI DOO | Karađorđeva 38/5 | 035/8871-404 065/5126-089 |
| Deliblato | ELEKTRO FRIGO BANE | Maršala Tita. 51. | 064/4324-974 |
| Donji tovarnik | H.O.M. SERVICE | Donji Tovarnik | 022/483-690 064/5077-127 |
| Gložani | STIVELEKTRO SB | Veljka Vlahovića 61 | 021/2288-399 063/8551-234 |
| Gornji milanovac | FRIGO TERM GM | Dragiše Nikolića 23 | 064/1923-648 |
| Gornji milanovac | SZTR "FRIGOSERVIS" | Vojvode Milana Obrenovića 35 | 032/711-524 064/1274-269 |
| Indija | EON-IN | Kraljice Jelene 20 | 063/1805-056 |
| Indija | SIMA R SZTR BRATISLAV SIMIĆ PR | Kralja Petra I broj 44 | 022/560-211 064/1238-606 |
| Ivanjica | TM TOPLOTA | Šume bb | 032/652-180 064/3880-642 |
| Jagodina | CRVENI DŽIN COMPUTERS | Kneginje Milice 16 | 064/3612-816 |
| Jagodina | DŽIN SOLUTIONS d.o.o. | Radmila Đorđevića 2/20 | 035/244-036 063/617-283 |
| Jagodina | ELEKTRO d.o.o. | Slavke Đurđević b1/3 | 035/8245-834 |
| Jagodina | FM ELEKTRO | Kneza Lazara L1,lok.7 | 064/3612-816 |
| Kač | MDM-TIM | Svetozara Miletića 27 | 064/5606-150 |
| Kanjiža | PANNON ELECTRONIC | Subotički put 2 | 024/873-502 |

| | | | |
|------------|-----------------------------|----------------------------|-----------------------------|
| Kikinda | BUS COMPUTERS DOO | Nemanjina 36 | 0230/402-740 062/224-432 |
| Kikinda | FRIGO TERMO MAX | Oslobođenja 9 | 060/5507-055 |
| Kikinda | XEON DOO KIKINDA | Svetosavska 68 | 065/2437-935 |
| Kladovo | ELEKTRO LUKS | Ritska 18 | 019/807-104 062/406-156 |
| Knjaževac | AB KLIMAELEKTRO | Knjaza Miloša 92 | 019/736-336 |
| Knjaževac | SZR „GAGISERVIS“ | Trgovište bb | 063-8089-332 |
| Kovin | DR FRIGO | Cara Lazara 87 | 063/8315-625 |
| Kovin | Termofrigo | Ive Lole Ribara 4 | 013/745-207 065/8332-176 |
| Kragujevac | FOKUS | Ljubiše Bogdanovića 14 | 034/314-400 065/3144-004 |
| Kragujevac | HOMEELEKTRO PLUS | Jovana Ristica 9 | 063/8390-649 |
| Kragujevac | MEGA FRIGO | Vladimira Rolovića 30 | 064/9756-126 |
| Kragujevac | PROFESIONAL | Kneza Danila 20 | 034/825-385 063/614-867 |
| Kragujevac | SERVIS COOL | Kneza Mihaila 52a | 034/362-942 063/8136-351 |
| Kragujevac | SLOBODA-CHERRY | Kneza Mihaila 89 | 034/360-630 066/6360-630 |
| Kraljevo | BOĆO ZUR | Oplanići 181 v | 036/355-005 064/1813-999 |
| Kraljevo | FRIGOKLIMA TOMICA | Majevička 7 | 064/0079-797 |
| Kruševac | ELGOR | Kralja Petra Prvog 105 | 037/456-149 063/8225-033 |
| Kruševac | FRIGO OPREMA DOO | Cara Lazara 382 | 037/456-456 064/1113-111 |
| Kruševac | MP COOLING | Dostojevskog 6/8 | 037/443-419 064/1369-044 |
| Kruševac | TERMO CONTROL | Srdaljska 15 | 064/1579-286 |
| Kruševac | ŽIS-INVEST IVICA STAJIĆ PR | Mihajla Pupina 2 | 037/886-324 063/1886-324 |
| Kucura | PAVIĆ INSTALACIJE SZR | Ise Sekickog 106 | 061/2987-123 |
| Kula | ELTEK | M Tita 266 c | 025/721-480 062/799-750 |
| Kula | PC+ | Maršala Tita 264b | 025/721-135 061/2096-479 |
| Kula | SONAR PC | Maršala Tita 266a | 025-729-460 065/5729-460 |
| Kula | TECHNO-SHOP | Trg oslobođenja 5 | 069/721-579 |
| Lapovo | MM MOBIL | Njegoševa 13/1 | 034/853-333 063/613-995 |
| Lazarevac | SERVIS BANE 985 DUDOVICA | Druga nova 6 Dudovica | 069/3015-015 |
| Lazarevac | FRIGO JANKOVIĆ SZTR | Dušana Petrovića Saneta 27 | 011/8119-080 063/341-359 |
| Leskovac | FRIGO JUG | Bulevar oslobođenja 173a | 016/215-727 064/2843-922 |
| Leskovac | FRIGO PAHULJA | V.Stepe 36 Gornje Stopanje | 063/1036-969 |
| Leskovac | GMS FRIGOTERM | Kopaonička 7 | 065/2812-620 |

| | | | |
|---------------------|--|------------------------------------|----------------------------------|
| Leskovac | HOME CENTAR VERA D.O.O. | Stanoja Glavaša 9 | 016/3441-144 |
| Leskovac | KATALOG DOO | Stepe Stepanovića 3 | 016/213-312 |
| Leskovac | SERVIS EL | Cara Lazara 27/17 | 016/250-778 064/1749-509 |
| Loznica | PLEROMA PLUS | Vladislava Bronjevskog 13 | 015/892-002 065/6787-678 |
| Loznica | S.Z.R. UNIVERZAL | Vojvode putnika 7 | 015/873-692 9521 064/8568-206 |
| Loznica | SERVIS MARJANOVIĆ SZTR | Vojvode Putnika 11 | 015/877-865 - |
| Lučani | TOP WOOD | Jugoslovenske armije 2 | 032/819-298 065/3607-790 |
| Ljig | CENTAR SERVIS | Kolubarska 1 | 014/3443-953 |
| Mačvanska mitrovića | DRAGAN ZABLACANSKI PR KENDIN | Brace Andonovic 18 | 063/7701-524 |
| Mionica | SERVIS BELE TEHNIKE MIONICA (TOLIĆ) | Tolić bb | 063/8689-440 |
| Mionica | SERVIS BELE TEHNIKE SBT | Selo Dučić Gornja Toplica | 014/66-330 063/8649-810 |
| Mladenovac | ON-LINE SZTR | Milutina Milankovića 14/1 | 011/6234- 813 065/8220-411 |
| Negotin | PREDIĆ PROMET OD | 12. septembra 14 | 019/544-969 |
| Negotin | TWEETY TR, ANA RADOVANOVIĆ PR | Kneza Mihaila 50 | 019/547-936 063/8544-289 |
| Niš | ELEKTROTERM POTIĆ d.o.o. | Obilićev venac 5 | 018/516-555 062/1140-603 |
| Niš | FRIGO ANJA | Bubanjska 16 | 018/280-169 064/1522-627 |
| Niš | FRIGO M | Rentgenova 17/26 | 064/5451-381 |
| Niš | FRIGO PINGVIN | Cvijičevo sokače br.8 Jelašnici | 064/2255-710 |
| Niš | FRIGOLUX | Ljubomira Nikolića 19/8 | 065/4243-700 |
| Niš | FRIGOMARKET PLUS | Obilićev venac 2 | 018/259-444 063/8967-347 |
| Niš | FRIGOMARKET PROMET | Jovana Ristića 55 | 065/8967-347 |
| Niš | INSTAL ELEKTRIK | Kosovke devojke, treći prilaz br.5 | 063/8738-588 |
| Niš | MD TRADE | Žarka Đurića 12a | 018/224-114 063/7252-085 |
| Niš | TOTAL KLIMA | Francuska 6 | 063/467-128 |
| Niš | YU MARKET | Južnomoravskih brigada 15 | 064/1483-469 |
| Niška banja | KLIMA SISTEMI PETKOVIĆ | Carice Teodore 10a | 018/4548-208 060/5060-177 |
| Nova pazova | FRIGO STANKOVIC | Vuka Karadžića 98 | 065/3319-577 |
| Nova pazova | GORAN IN | R.Pavlović 18 | 063/267-064 |
| Novi kneževac | ELEKTROSERVIS | Zmaj Jovina 67 | 0230/81-284 063/539-720 |
| Novi sad | HERC d.o.o. Veternik | Bulevar Evrope 19 | 021/2544-864 063/542-131 |
| Novi sad | ELZO SERVIS | Bul. Jovana Dučića 25/143 | 021/400-943 061/2312-844 |

| | | | |
|-----------|--|---------------------------|---|
| Novi sad | FRIGO-MILAN SZR MILAN LUŽAIĆ PR | Ljubena Karavelova 17 | 064/1143-903 |
| Novi sad | MISTER COOL | Pavleka Miškina 31 | 021/6398-350 063/344-667 |
| Novi sad | PROSPERO d.o.o. | Narodnog fronta 30 | 021/453-869 063/512-671 |
| Novi sad | SILER | Stanoja Glavaša 114 | 021/503-218 066/333-109 |
| Obrenovac | FRIGO NIDŽA | Kralja Petra I 15 | 011/7872-228 064/3675-742 |
| Obrenovac | MICROHARD | Miloša Obrenovića 140 | 063/308-114 |
| Obrenovac | ŠAINOVIĆ I SINOVI | Belopoljska 1 | 011/8725-799 |
| Odžaci | BAGZI TIM | Jurija Gagarina 24 | 069/2644-787 |
| Odžaci | ŠPAKI ELEKTRO | Hajduk Veljka 13 | 063/8122-890 |
| Opovo | PR TRGOVINSKA RADNJA I SERVIS NICOL-COMERC | B.Kidriča 25 | 013/682-280 |
| Pančevo | FRIGO ACA PAN | Narodnog Fronta br.5 | 013/602-696 064/1472-547 |
| Pančevo | FRIGO PEĐA | Karađorđeva 67 | 013/301-300 063/7712-416 |
| Pančevo | FRIGOINŽENJERING | Petra Kočića 2 | 013/512-780 063/329-433 |
| Pančevo | RANZ FRIGOELEKTRO | Milke Marković 5 | 064/1826-615 |
| Pančevo | SERVIS BUNDALO | Đerdapska 16 | 013/371-530 060/3715-300 |
| Pančevo | SERVIS RATKOVIĆ | Semberijska 14 | 013/370-101 063/472-524 |
| Paraćin | DRAGAN SIMIĆ PR KLIMA EUROCOOL | Lebina bb | 062/9744-356 |
| Paraćin | SALE SAT | Vojvode Mišića 19 | 035/565-290 060/5565-290 |
| Paraćin | SERVIS EUROCOOL | Davidovac bb | 069/606-704 |
| Petrijevo | KLIMA SD | Nemanjina 10 | 063-665-550 |
| Pirot | EKO MRAZ | Dragoljuba Milenkovića 28 | 010/311-141 063/8220-748 |
| Pirot | SERVIS FRIGOSTROJ | Trg Republike 37 | 064/2624-800 010 336-607 064-2624-800 |
| Pirot | TRGOVINSKA RADNJA STOJANOVIĆ | Nikole Pašića bb | 064/2774-039 |
| Požarevac | AGATEL DOO POŽAREVAC | Nemanjina 11 | 012/541-175 060/6410-766 |
| Požarevac | AVS | Kosančićeva 23 | 012/556-188 069/1556-188 |
| Požarevac | GSM&PC SHOP | Trg oslobođenja 3 | 012/532-551 |
| Požarevac | ZENER | Mišarska 5 | 012/550-536 069-135-1903 |
| Priboj | STZR STARI GRAD | 12 Januar 30 | 033/2448-102 064/5595-825 |
| Prokuplje | FRIGO-TERM CENIC | Jug Bogdanova 50 | 064/4429-091 |

| | | | |
|------------------------|--|----------------------------|---|
| Ratkovo | FRIGO MIKOVIĆ | Ratka Pavlovića 37 | 063/8418-229 |
| Ruma | COOL WATT | Vrdnicka 78 | 060/5005-200 |
| Ruma | RADOVAN STOJADINOVIĆ PR ZANATSKA RADNJA SBT RAŠA | Vladimira Nazora 4 | 060/4713-120 |
| Ruma | T.C.SISTEM | Prvomajska 46 | 022/471-584 064/9842-064 |
| Sefkerin | FRIGOMANEX | Jna 47 | 066/5511-536 |
| Senta | OMEGA ELEKTRO SERVIS I PREVOZNIK | Madrač Imrea9/A | 024/815-565 064/0812-720 |
| Smederevo | ANTARTIK | Partizanska 75 | 062/362-481 |
| Smederevo | ELEKTRO DIPOL | Oslobođenja 66 | 064/3676-765 |
| Smederevo | FRIGOSISITEM-SD | Crvene armije 55 | 064/1205-661 |
| Smederevo | FINE COOLING | Kosovke devojke 11 | 060/5005-663 |
| Smederevo | SATURNUS | Karađorđeva 12/136 | 026/616-785 063/231-631 |
| Smederevska palanka | MARINKO MAJSTOR | Srpskog ustanka 123/2 | 063/7747-441 |
| Sombor | SERVIS DALE | Miladina i nikole Kunića 7 | 025/302-339 063-554-082 |
| Sombor | ZTKR ELEKTRON-M | Nikole Vukičevića 5/2 | 025/450-397 063/7732-675 |
| Sremska mitrovica | DELTA PLUS | Fruškogorska25 | 022/617-890 064/1237-670 i 060/6280-999 |
| Sremska mitrovica | DMG TIM | Marka Peričina 3/7 | 064/8709-111 |
| Sremska mitrovica | KLIMATRONIK SERVIS | Josifa Rajačića 14 | 060/1754-444 |
| Srpski miletić | FRIGO DADO | Dunavska 11 | 025/5764-841 063/593-466 |
| Stara pazova | ETERM | Janka Čajaka 20 | 022/312-293 062/592-181 |
| Stara pazova | SISTEM PLUS | Zmaj Jovina 15 | 060/6606-891 |
| Subotica | BX COOL COMPLEX DOO | Istarska 19 | 064/6808-900 |
| Subotica | CITY RTV | Zrinjskog i Frankopana 36 | 024/533-070 063/533-078 |
| Subotica | DADO SERVIS | Bihačka 17 | 024/543-031 |
| Subotica | ELEKTRIČAR 024 | Jelene Četković 22 | 061/2701-854 |
| Subotica | ERA SZR | Jovan Mikića 150 | 024/532-916 063/8631-576 |
| Subotica | IVICA STANTIĆ PR FRIGO LINE SU | Svete Katarine 36 | 066/001-989 |
| Subotica | MEGA ELEKTRO | Stipe Grgića 75 | 024/536-514 063/504-537 |
| Subotica | MIDDLE TECH Robert Sabo PR | Bele Bartoka 52 | 024/263-177 064/6694-903 |
| Subotica | NM INŽENJERING | Španskih Boraca 99 | 069/2394-718 |
| Subotica | SLAĐAN STEVIĆ PR GEKKON SERVIS | Bokeljska 36 | 063/662-442 |
| Subotica | SU EKONOMIK SZR | Marka Oreškovića 16 | 024/566-533 063/1056-788 |

| | | | |
|------------------|------------------------------------|--------------------------------------|------------------------------|
| Subotica | WM servis | Ruzmarina 2 ; PJ Frankopanska 36 | 024/523-764 063/519-505 |
| Surdulica | PTMR COLESOFT | Srpskih Vladara 51 | 064-6339-915 |
| Šabac | AXEL SERVICE d.o.o. | Vladike Joanikija Neškovića 4 | 015/304-445 063/326-303 |
| Šabac | CENTRAL SERVICE d.o.o. | Prote Smiljanica 52 | 015/319-530 063/346-222 |
| Šabac | HARMONIKA | Marička 23 | 015/304-246 063/362-218 |
| Šabac | SERVIS I TRGOVINA MIJAILOVIC | Prote Smiljanica 2 | 064/4088-015 |
| Šabac | ZTR OBRADOVIĆ | Kralja Milana 47a | 015/344-997 |
| Šid | FRIGOMONT | Vojvođanska 104 c | 022/731-634 063/8186-751 |
| Šid | MEGA SERVIS SZR | Solunskih dobrovoljaca 62, Berkasovo | 022/718-230 063/8268-326 |
| Šid | SZR SUBIĆ | Petra Kočića 44 | 022/711-448 061/1737-366 |
| Štubik | FRIGO MIČA | Beogradska bb | 063/8033-109 |
| Tečić | AKTIMO | Tečić bb | 069/3002-240 |
| Trstenik | SZR FRIGO SERVIS | Odžaci bb | 037/711-825 064/1816-341 |
| Ub stublenica | TMD INSTAL | Milana Munjaša br1 | 065/6511-553 |
| Užice | ELEKTROUNIVERZAL | Vidovdanska 32 | 064/6145-808 |
| Užice | FRIGO-M | D Tucovića 151/2 | 064/2392-971 |
| Valjevo | FRIGO-ELEKTRO SERVIS | Čegarska 11 | 014/226-964 |
| Valjevo | STR AŠKOVIĆ | Jakova Nenadovića 20 | 014/230-049 063/8154-767 |
| Valjevo | UNIKOM UNISAT STZR JAGODIĆ DUŠKO | Uzun Mirkova bb | 064/2356-777 |
| Varvarin | KUĆA TEHNIKE | Jove Kursule BB | 037/789-402 |
| Varvarin | SBT 2017 | Lole Ribara 18 | 064/1398-274 |
| Velika moštanica | DELTA FRIGOMATIC DRAGAN | 1. maj 77 | 011/4094-844 |
| Velika plana | TEHNOSERVIS | Nikole Pašića bb | 026/522-097 062/261-622 |
| Veliko gradište | FRIGO SERVIS | Vojvode Milenka 3 | 012/661-050 |
| Vladičin han | NIKOLA KOSTIĆ PR 13 OKTOBAR | Beogradska 29 | 069/5501-017 |
| Vlasotince | SERVIS RANĐELOVIĆ | 12. brigade bb | 016/876-181 063/8220-926 |
| Vojka | FRIGO MITO | Svetog Save 99 | 063/1777-335 |
| Vranje | ELEKTROFRIGO | Prizrenska 6 | 063/1196-660 |
| Vrnjačka banja | FRIGO ELEKTRIK LUKIC | Nemanjina 15 | 036/612-080 064/1940-733 |
| Vrnjačka banja | SLOBODAN ĐURIĆ PR FRIGOCIPELEKTRON | Gočka 92, Ruđinci | 036/5469-161 064/1925-438 |
| Vršac | R.Z.P.K.A I TRGOVINA BEOSERVIS | Svetozara Miletića 84 | 064-5403-280 |
| Vršac | TERMOMIKI | Svetosavski trg 6a | 062/461-109 |
| Vučje | FRIGO SISTEM | JNA 38 | 016/427-382 063/7603-509 |

| | | | |
|---------------------|---|-------------------|------------------------------|
| Zabrđe kod petrovca | FREON | Zabrđe BB | 063/388-750 |
| Zaječar | MILENKOVIĆ SERVIS OBOD 2 | Kursulina 20 | 019/463-047 063-485-875 |
| Zaječar | SZR KLIMA ZAJEČAR | Nikole Pašića 224 | 063/8468-504 063/8141-396 |
| Zrenjanin | ART COOL | Ivana Aćina 35 | 023/530-877 063/7763-259 |
| Zrenjanin | KLEM | S.Mokranjca12 | 060/0525-901 |
| Zrenjanin | KLIMA CENTAR | Valjevska 25 | 060-5114-949 |
| Zrenjanin | RADIVOJ GAGIĆ PR SERVIS GAGIĆ | Rade Trnića 31 | 064/2674-400 |
| Zrenjanin | ZDRAVKO PETROVIĆ PR SERVIS BELE TEHNIKE | Bačka 130 | 063/515-562 |
| Žabalj | DEJAN ŠARIN PR D&S KLIMA SERVIS | Petra Kočića | 069/1465-227 |

POŠTOVANI!

Zahvaljujemo na kupovini Vivax uređaja i nadamo se da ćete biti zadovoljni odabirom. Ako u garantnom roku bude potrebna popravka proizvoda, molimo savjetujte se sa ovlaštenim prodavačem koji Vam je proizvod prodao ili nas kontaktirajte na dole navedene brojeve i adrese. MOLIMO VAS DA PRIJE UPOTREBE PROIZVODA PAŽLJIVO PROČITATE UPUTSTVA PRILOŽENA UZ PROIZVOD!

GARANTNI LIST

VIVAX

BiH

MODEL UREĐAJA

SERIJSKI BROJ

DATUM PRODAJE

BROJ RAČUNA PRODAVOACA

POTPIS I PEČAT PRODAVOACA

| |
|--|
| |
| |
| |
| |
| |

1. Preuzimamo obavezu da besplatno popravimo ili zamijenimo neispravne dijelove Vivax cool klima uređaja koji bi se takvim pokazali za vrijeme trajanja garancije, kao greška prilikom izrade ili montaže
Ovom garancijom garantujemo da će predmet ove garancije raditi bez pogreške uzrokovane eventualnom lošom izradom ili lošim materijalom izrade. Svi, eventualno nastali, kvarovi biće besplatno otklonjeni u ovlaštenom servisu u garantnom roku.

USLOVI GARANCIJE:

2. Garancija na Vivax cool klima uređaje počinje teći od dana kupovine proizvoda i traje **24 mjeseca**, osim modela **ACP-xxxxCCxxxxx, ACP-xxxxCTxxxxx, ACP-xxxxDTxxxxx, ACP-xxxxCFxxxxx, ACP-xxxxFSxxxxx** za koje vrijedi garancija u trajanju od **12 mjeseci**
3. **Garancija na uređaje u upotrebi produžuje se za sljedećih 12 mjeseci nakon izvršenja garantnog servisnog pregleda od strane ovlaštenog servisa.**
4. Garancija se može produžavati ukupno **tri puta**, osim modela **ACP-xxxxCCxxxxx, ACP-xxxxCTxxxxx, ACP-xxxxDTxxxxx, ACP-xxxxCFxxxxx, ACP-xxxxFSxxxxx** za koje se garancija može produživati četiri puta, što u ukupnom trajanju može iznositi maksimalno **60 mjeseci**
5. Garantni servisni pregled naplaćuje ovlašteni servis po cjenovniku zastupnika KimTec d.o.o. i/ili Kim Tec servis d.o.o. i ovjerava garantni list što dokazuje produženje i valjanost garancije
6. **Garancija vrijedi ako su montaža ili servis Vivax cool klima uređaja obavljani od strane ovlaštenog servisa kojeg je ovlastio zastupnik Kimtec d.o.o..**
7. Vivax cool klima uređaj kao cjelinu čine unutarnja jedinica, instalacija i vanjska jedinica koji su pravilno odabrani i koji međusobno odgovaraju po modelu i snazi.
8. U slučaju kvara na Vivax cool klima uređaju obvezujemo se da ćemo isti popraviti u najkraćem mogućem roku, a najkasnije u roku 45 dana, ako se Vivax cool klima uređaj ne može popraviti ili se ne popravi u roku od 45 dana, biće zamijenjen novim. Ako popravak Vivax cool klima uređaja traje duže od 10 dana, garancija će se produžiti za vrijeme trajanja popravka.
9. Garancija se priznaje samo uz račun o kupovini, te uz ovaj garantni list koji mora biti ispravno popunjen i ovjeren od strane prodavca, ovlaštenog montažera ili servisera.
10. Davaoc garancije osigurava servis i rezervne dijelova 7 godina od datuma kupnje Vivax cool klima uređaj
11. **GARANCIJA NE OBUHVATA:**
Redovnu provjeru, održavanje uz zamjenu dijelova koji se troše normalnom upotrebom, prilagođavanje ili promjene za poboljšanje proizvoda za primjenu koji nisu opisane u tehničkim uputstvima za korištenje, osim ako je za te preinake predočena saglasnost M SAN GRUPA d.o.o.; i KimTec d.o.o. i/ili Kim Tec servis d.o.o.
12. **Garancija se ne priznaje u sljedećim slučajevima:**
Ako kupac ne predoči ispravan garantni list i račun o kupovini.
Ako se kupac nije pridržavao uputstava o korištenju proizvoda.
Ako je proizvod otvaran, prepravljan ili popravljan od neovlaštene osobe.
Ako su kvarovi na proizvodu nastali djelovanjem više sile kao što su: udar groma, strujni udari u električnoj mreži elementarne nepogode i slično.
Ako su kvarovi nastali oštećivanjem zbog nepropisane upotrebe ili nepravilnim transportiranjem. Ako je kvar nastao pogreškom u sustavu na koji je proizvod priključen.
Ovom garancijom nisu obuhvaćene neispravnosti koje bi nastala zbog nepažljivog ili nestručnog rukovanja, zbog nepoštivanja uputa proizvođača za rukovanje tj. zbog bilo koje okolnosti koja se ne može pripisati grešci izrade uređaja. Montažom, servisnim pregledom ili popravkom Vivax cool klima uređaja od strane neovlaštenog servisa, radionice ili treće osobe, kupac Vivax cool klima uređaja gubi pravo na garanciju.
Iz garancije je isključena odgovornost za eventualne povrede koje bi mogle pretrpjeti osobe ili životinje, odnosno za bilo koje štete nastale funkcioniranjem ili nefunkcioniranjem uređaja
Garantni kuponi služe za pravdanje popravaka uređaja
Prilikom popravka servis ima pravo zadržati jedan garantni kupon

Naziv firme davatelja garancije: **Kim Tec d.o.o., Poslovni centar 96-2, 72250 Vitez,**
Tel: 030 718 800, FAX: 033 755 897,
e-mail: vivax@kimtec.ba

| | | |
|------------------------------------|--|--|
| DATUM SERVISNE INTERVENCIJE | | |
| DATUM POPRAVKA | | |
| DATUM SERVISNE INTERVENCIJE | | |
| DATUM POPRAVKA | | |
| DATUM SERVISNE INTERVENCIJE | | |
| DATUM POPRAVKA | | |

Ugradnja

| DATUM UGRADNJE | OVLAŠTENI SERVIS I POTPIS |
|-----------------------|----------------------------------|
| | |

Servisni periodični pregled i održavanje:

| | |
|----------------------------|--------------------------|
| Servisni pregled 1 | Ovlašteni servis: |
| Datum: | |
| Vrijedi do: | |
| Servisni pregled 2 | Ovlašteni servis: |
| Datum: | |
| Vrijedi do: | |
| Servisni pregled 3 | Ovlašteni servis: |
| Datum: | |
| Vrijedi do: | |
| Servisni pregled 4* | Ovlašteni servis: |
| Datum: | |
| Vrijedi do: | |

* **Servisni pregled 4 vrijedi samo za modele s osnovnom garancijom od 12 mjeseci**

| Grad | Servis | Adresa | Telefon |
|----------------|--|--------------------------------|------------------------------|
| Vitez | Kim Tec-Servis d.o.o. | Poslovni centar 96-2 | 030718844 |
| Banovići | Servis rashladne op. i bijele teh. Klimatronic | 119 Muslimanske brdske brigade | 061 287 708 |
| Banja Luka | Servis Preradović | Oplenačka br.2. | 051 280 500, 051 280 505, |
| Banja Luka | MCT Elektronik d.o.o. | Obiličeva 4 Trn | 051 508 080 |
| Banja Luka | Sloboda SOD | Milice Stojadinović S.6 | 065 523 658, 051 438 908 |
| Banja Luka | Kod Ivce szr rtv servis | Voždovačka 7 | 051-301-449 |
| Banja Luka | East Code d.o.o. | Bulevar Desanke M. 10 | 051 435 595 |
| Banja Luka | Frigomatik d.o.o. | Petra Preradovića 13 | 051 315 950 |
| Banja Luka | Elektronik servis s.p. Rosić | Zemunska 6 | 051/354-802 |
| Banja Luka | Dekta PC | Srpska 107 | 065 446 333, 051 216 292 |
| Banja Luka | Elektromont s.o. | Nenada Kostića 92 | 065 566 141, 051 386 008 |
| Bihać | Elektronik d.o.o. | Trg Slobode 8 | 037 222 626 |
| Bijeljina | Szr RTV Servis TM-Elektronika | Galac 140 | 055 207 294 |
| Bijeljina | Sony Computers | Filipa Višnjića 67 | 065 584 303, 055 215 999 |
| Bijeljina | Elkos | Vojvode stepe 10A | 065 209 009 |
| Bijeljina | BG elektronik | Meše Selimovića 45 | 055 201 001 |
| Bijeljina | Copitrade d.o.o. | Njegoševa 6 | 055 207 755 |
| Bijeljina | MaxMare d.o.o. | Meše Selimovića 4 | 055 225 040 |
| Bijeljina | Elektro servis ZTR | Dimitrija Tucakovića 160 | 055 243 900, 065 517 553 |
| Bosanska Krupa | Frijo Sani | Hasana Kikića 2 | 061 520 661 |
| Bosanska Krupa | Instal-N | Sokak bb | 061 935 535 |
| Brčko | Elektro servis Rain | Brače Čuskića 24 | 065 621 645, 049 214 780 |
| Brčko | Goja | Uzunovića 34 | 049 214 788, 066 451 821 |
| Brčko | MD Montel d.o.o. | Brače Čuskića | 065 532 001 |
| Brčko | Servis Đukanović | R.DŽ. Čauševića 8 | 037 222 626, 065 529 798 |
| Brčko | Damir-D-S | Mostarska 156C | 061 961 609 |
| Brčko | Konak d.o.o. | Rizaha Štetića | 049 235 230 |
| Brod | GG Elektro | Kralja P. oslobođioca | 065 0130645 |
| Cazin | Univerzal elektro obrt | Gen. Izeta Nanića | 037 511 590, 061 794 935 |
| Čapljina | Hipex d.o.o. | Gabela bb | 063 323015 |
| Derventa | Elin-M s.p. | 1.maja br. 111 | 053 971 270, 065 478 903 |
| Derventa | AMD elektro | Vase Pelagića 80 | 065 634 985 |

| | | | |
|-------------------|-------------------------------|-------------------------|-----------------------------|
| Derventa | Audio Video Cen. Danijel s.p. | N. Pašića 44 | 065 076 788 |
| Doboj | Gama a&a sztur | Celjska 41 | 053 226 966 |
| Doboj | EM-elektronik | Kralja Aleksandra 211 | 066 804 663 |
| Goražde | Tehnika d.o.o. | Mravinjac bb | 061 156 046 |
| Gračanica | Dinnet d.o.o. | Kamenica bb | 062 346 289 |
| Gradačac | Elektroservis Hido | H.K. Gradašćevića 110 | 061 103 900, 061 178 431 |
| Gradiška | Koming d.o.o. | Vindovdanska 21 | 065 525 637, 051 814 755 |
| Gradiška | zr Frigoelektro | 5. Kozarske brigade 11 | 066 488 479 |
| Istočno Sarajevo | Frigo-elektro s.p. | Draže Mihajlovića 64 | 065 142 473 |
| Istočno Sarajevo | Klima shop s.p. | Spasovdanska br.6. | 057 344 104 |
| Kakanj | Delta Term | Donji Banjevac | 061 871 359 |
| Kalesija | Obrt. Radnja Servis Gutić | Petrovice gornje bb | 061 731 245 |
| Kalesija | FinTech d.o.o. | Žrtava genocida u S.bb | 035 631 111 |
| Kiseljak Sarajevo | Michelangelo d.o.o. | Ive Andrića 1 | 063 339 044 |
| Konjic | ZR Elektron | Varda30 | 061 153 988 |
| Konjic | AC mont | Šunji 45 | 061 687 484 |
| Kotor Varoš | SDM servis | Stefana Nemanje bb | 065 587 740, 065 848 542 |
| Kozarac | Ello | Kevljani | 061 748 563 |
| Livno | szr Servis Penjak | Brina bb | 063 154 807 |
| Lukavac | Imel d.o.o. | Sjendera Kulenovića bb | 035 553504 |
| Lukavac | PC oner d.o.o. | Branilaca Bosne bb | 035 555 999, 061 724 775 |
| Ljubuški | Šarmont, samostalni obrt | Proboj bb | 063 898 873 |
| Ljubuški | Elektroservis | Veljaci bb | 063 372 605 |
| Maglaj | PC Biro Shop | Viteške br.8. | 032 604 330, 061 783 656 |
| Mostar | Elektro Frigo Lerić tr | Šehovina 26 | 063 316 712, 036 577 407 |
| Mostar | PC centar d.o.o. | Kralja Tvrtka 5 | 036 313 110 |
| Mostar | Megamarkt d.o.o. | Muje Pašića bb | 036 513 913 |
| Mostar | Frigoterm d.o.o. | Vrapčići bb | 036 575 130 |
| Mostar | K.B. d.o.o. | Blajbluških žrtava b.b. | 036 321 140 |
| Novi Grad | Elektro frigo mont | Dobrljin 84 | 065 674 553 |
| Orašje | MMC d.o.o. | VIII ulica bb | 031 714 495, 063 714 495 |
| Posušje | Digitrend d.o.o. | Vukovarska bb | 039 680 920 |
| Prijedor | Klima San | Boška Buhe 12 | 065 585 969 |
| Prijedor | PR Media Market | Miloša obrenovića bb | 052 233 833, 065 788 667 |
| Prijedor | AC Frigo | Aerodromska ulica 3b | 065 659 612 |
| Prnjavor | Beki electronic | Vladike Platona 21 | 061 663 645 |
| Rogatica | Elektromehanika | Zanatski trg br.1 | 065 341 135 |
| Sanski Most | TNG d.o.o. | Otoke b.b. | 037 684 701 |
| Sanski Most | H-Mont | Banjalučka 21 | 062 5370298 |
| Sarajevo | Asko szd | Igmanska 47 | 061/208 305 |

| | | | |
|----------------|---------------------------------------|--------------------------|------------------------------|
| Sarajevo | Imtec | Pijačna 114 | 033 688 005 |
| Sarajevo | AS Consult d.o.o. | Tvornička br. 3 Ilidža | 061 162 755 |
| Široki Brijed | Protehna d.o.o. | Knešpolje bb | 063 440 652 |
| Tešanj | Mepromex | Lepenica | 032 662 795 |
| Tešanj | Elektro Frigo | Raduša bb | 062 984 117 |
| Travnik | Elektro servis Agić | Mehmed Paše Kukavice | 061 326 756 |
| Trebinje | Elektro-Mehanika Milojević s.p. | Zasad bb | 065 691419, 059 260 694 |
| Trebinje | Krunić komerc d.o.o. | Luke Petkovića | 059 273 040 |
| Trebinje | Odavić d.o.o. | Vojvode Sindelića S4 | 059 272 010 |
| Trebinje | Elektromontaža Trebinje d.o.o. | Kolubarska bb | 059 261 081 |
| Trebinje | Makel Instalacije d.o.o. | M. Crnjanskog 10 | 059 226 348 |
| Tuzla | Ftešan | Genelac | 035 251479 |
| Tuzla | Euroline d.o.o. | Stupine 37 | 061 101 717, 035 276 228 |
| Tuzla | Telix d.o.o. | Rudarska 61 | 035 277 100, 061 138 470 |
| Tuzla | SK Sistem | Ivana Markovića | 035 311 650 |
| Tuzla | o.d. el.servis Klimalux-Dine | Slavka Mičića 12 | 061 140652 |
| Tuzla | Frigo Servis | Nesiba Malkića 6 | 061 724 026 |
| Tuzla | MOS Tech d.o.o. | Branislava Nušića 51 | 035 287 287 |
| Velika Kladuša | Elektron | Trnivačka 8 | 037 770 514, 061 772 737 |
| Velika Kladuša | Elektronika i Telekomunikcije | Kozaračka br.14 | 037 771 955, 061 591 702 |
| Velika Kladuša | Dess centar d.o.o. | 1.maj bb | 037 772 207 |
| Velika Kladuša | Prodata d.o.o. | Mahmuta Zulića bb | 037 770 079 |
| Visoko | Obrt Telecomp | Gornje Rosulje bb | 061 401 219 |
| Visoko | Mualvis d.o.o. | Ibrahima Hodžića 2 | 061 146 238 |
| Višegrad | sztr Kruna | Kralja Petra bb | 065 626 561 , 058 620 943 |
| Vitez | Eltih s.z.r. | Stjepana Radića 78 | 063 333 401 |
| Zenica | Intercom | Vrandučka 71b | 032 446 580 |
| Zenica | PPUD Klimatizacija-grijanje d.o.o. | Sarajevska 290 | 061 137 338, 070 216 440 |
| Zenica | DR Elfix | Zmaja od Bosne bb | 062 402 040 |
| Zepče | Frigo elektronik d.o.o. | Stjepana Tomaševića bb | 032 881 762, 061 108 510 |
| Zvornik | BMG elektronik ztr sp | Vuka Karadžića | 056 215 300, 065 958 025 |
| Živinice | Refresh inženjering d.o.o. | 25. novembar , lamela IV | 061 655 583 |
| Živinice | EM electronics d.o.o. | Pašage Gogića bb | 035 773 408, 061 100 150 |
| Živinice | Fleš inženjering | Alije Izetbegovića 32 | 061 655 853 |

ПОЧИТУВАНИ ПОТРОШУВАЧИ!

Ви благодариме што одбравте да купите клима уред Vivax cool. Се надеваме дека ќе бидете задоволни со Вашиот избор.

ПРЕД УПОТРЕБА НА ПРОИЗВОДОТ, ВЕ МОЛИМЕ ВНИМАТЕЛНО ДА ЈА ПРОЧИТАТЕ ТЕХНИЧКАТА ДОКУМЕНТАЦИЈА И ПРИЛОЖЕНИТЕ УПАТСТВА!

ГАРАНТЕН ЛИСТ

VIVAX

МК

МОДЕЛ НА УРЕД

СЕРИСКИ БРОЈ

ДАТУМ НА ПРОДАЖБА

БРОЈ НА СМЕТКА

НАПРОДАВАЧОТ

ПОТПИС И ПЕЧАТ НА ПРОД.

ДАТУМ НА МОНТАЖА

СЕРВИС/МОНТАЖЕР

| |
|--|
| |
| |
| |
| |
| |
| |
| |
| |

Со оваа гаранција произведувачот ви гарантира преку увозникот Паком Компани дооел за во Македонија бесплатна поправка а на уредот во склад со важечките прописи наведени во овој гарантен лист.

- Преземаме обврска бесплатно да ги замениме или поправиме неисправните делови на клима уредот Vivax cool чија неисправност се појавила за време на гарантниот рок како грешка во изработката
- Гаранцијата на уредите Vivax cool започнува да тече од денот на купувањето на производот и трае **24 месеци** освен за моделите **АСР-xxxxСХxxxx, АСР-xxxxСТxxxx, АСР-xxxxDTxxxx, АСР-xxxxCFxxxx, АСР-xxxxFSxxxx** за кои гаранцијата трае **12 месеци**.
- Гаранцијата на уредите може да се продолжи за дополнителни **12 месеци по извршен сервисен преглед** од страна на овластен сервис.
- Гарантниот сервисен преглед го наплатува овластениот сервис согласно ценовникот на застапникот Паком Компани дооел и го заверува гарантниот лист со што се докажува продолжувањето и важноста на гаранцијата.
- Гаранцијата важи ако монтажата и сервисните услуги на клима уредот Vivax cool се извршени од страна на овластен сервис од страна на застапникот Паком Компани.
- Vivax cool клима уредите се составени од внатрешна единица, инсталација и надворешна единица кои се внимателно одбрани и компатибилни според моделот и силата.
- Во случај на појава на дефект кај клима уред Vivax cool се обврзуваме дека ќе извршиме поправка во најкраток можен рок а најдоцна до 30 дена.
- Ако не може да се поправи уредот Vivax cool или не биде поправен во рок од 30 дена, ќе биде заменет со нов.
- Ако поправката на клима уредот Vivax cool трае подолго од 10 дена, гаранцијата се продолжува за времетраењето на поправката.
- Гаранцијата се признава само со приложена сметка и овој гарантен лист кој мора да биде исправно пополнет и заверен од страна на продавачот, овластениот монтажнер и сервисер.
- Давателот на гаранцијата обезбедува сервис и резервни делови за време од 7 години од датумот на купување на клима уредот Vivax cool.
- Во гаранцијата не се вклучени дефектите што настанале поради неисправна струјна мрежа, преднапонски удари, удари од гром или други временски непогоди и оштетувања предизвикани од виши сили
- Со оваа гаранција не се опфатени неисправностите кои би можеле да настанат поради невнимателно или нестручно ракување, поради непочитување на упатствата на произведувачот за ракување или други околности што не претставуваат грешка во изработката на уредот. • Со монтажа, сервис или поправка на клима уредите Vivax cool од неовластен сервис, работилница или трети лица, купувачот на клима уредот Vivax cool губи право на гаранција.
- Од гаранцијата е исклучена одговорност за евентуални повреди врз лица и животни односно штети што настанале од функционирањето или нефункционирањето на уредот.
- Гарантните купони служат за правдање на поправките на уредот.
- При поправката сервисот има право да задржи еден купон.

Име на фирмата-давател на гаранција: Паком Компани ДООЕЛ
ул. Јадранска Магистрала 12, 1000 Скопје, тел.02 3202-800

Централен сервис: Контакт 2000-Скопје
ул.10 бр.10 Аеродром, Скопје
Тел. 02 246-0000

Паком Компани дооел,
Јадранска магистрала бр.12, Скопје
Тел. 02/ 3202 800, факс 02/3202 892

| | | |
|---------------------------------------|--|--|
| ДАТУМ НА ПРИЕМ НА УРЕДОТ ВО СЕРВИС | | |
| ДАТУМ НА ПОПРАВАЊЕ | | |
| ДАТУМ НА ПРИЕМ НА УРЕДОТ ВО СЕРВИС | | |
| ДАТУМ НА ПОПРАВАЊЕ | | |
| ДАТУМ НА ПРИЕМ НА УРЕДОТ ВО СЕРВИС | | |
| ДАТУМ НА ПОПРАВАЊЕ | | |

ИНСТАЛАЦИЈА

| ДАТУМ НА ИНСТАЛАЦИЈА | ОВЛАСТЕН СЕРВИС И ПОТПИС |
|----------------------|--------------------------|
| | |

СЕРВИСЕН ПРЕГЛЕД ОД СТРАНА НА ОВЛАСТЕН СЕРВИС:

| | |
|---------------------|------------------|
| Сервисен преглед 1 | Овластен сервис: |
| Сервис: | |
| Датум / Важи до : | |
| Сервисен преглед 2 | Овластен сервис: |
| Сервис: | |
| Датум / Важи до : | |
| Сервисен преглед 3 | Овластен сервис: |
| Сервис: | |
| Датум / Важи до : | |
| Сервисен преглед 4* | Овластен сервис: |
| Сервис: | |
| Датум / Важи до : | |

* Сервисен преглед 4 важи само за модели со основна гаранција од 12 месеци.

| Град | Сервис | Адреса | Телефон |
|--|---------------------------|--------------------------|-------------|
| Битола | Фригомонт | Трифун Пановски 28 | 070 269 313 |
| Битола | Г Монт | Дебарска 125б | 075 694 058 |
| Велес | Електрон | Маршал Тито 108 | 043 231 381 |
| Гевгелија | Хот Контрол | Солунска 5 | 075 650 888 |
| Гевгелија | Еко Фриго Терм | Иво Лола Рибар 43 | 034 216 948 |
| Гостивар | Сервис Фриго | Никола Парапунов 72 | 070 215 420 |
| Демир Хисар | Алианса Клима Контрола | 2-ри Септември бр.2 | 075 387 522 |
| Дојран | АБА Пеливанов | с. Фурка | 071 471 583 |
| Кавадарци | Далас Експрес | Вишешница 6 | 043 416 869 |
| Кавадарци | Тим Корпорејшн (КЛИМИ.МК) | Ѓуро Салај 15-1/11 | 070 325 300 |
| Кавадарци | Аџе Сервис | Бел Камен 45 | 070 394 374 |
| Кичево | Разлади ЕМ-АА | 4-ти Јули 125 | 071 338 875 |
| Кочани | Ипсе Инт дооел | Скопска 2/7 | 075 905 525 |
| Кочани | Филаделфија | Цар Самуил 53б | 033 279 654 |
| Кратово | Делта Инженеринг | Лазар Софијанов 7 | 070 800 422 |
| Крива Паланка | Ампер Младен | Борис Трајковски 19 | 031 374 083 |
| Куманово | Мулти Шоп Иги | Пионерска 13 | 031 413 400 |
| Охрид | Рит Електроника | Туристичка 44а | 046 261 281 |
| Пехчево,Берово, Делчево, Мак. Каменица | Алфа Електротехника | Ванчо Китанов 17 | 070 210 685 |
| Прилеп | МИС Електрокомпани | 11 Октомври 7А | 048 427 009 |
| Прилеп | Владо Компани | Струшка 40/1 | 048 551 290 |
| Прилеп | Електро Точила | Сотка Ѓорѓиоски бб. | 070 208 290 |
| Пробиштип | Сервис Диме | Едвард Кардељ 5 | 075 546 531 |
| Ресен | Владо Блажевски | | 070 249 343 |
| Свети Николе | С-М | Ленинова бб | 070 632 829 |
| Скопје | Контакт 2000 | Борис Трајковски-7 бр.85 | 02 2460 000 |
| Скопје | Филекс-Ком | Франц Прешерн 255 | 02 3232 228 |
| Скопје | ТАС Предраг | Мирковци бб | 070 370 118 |
| Струга | Мактри Ојлески | Наум Наумоски Борче 28 | 075 521 691 |
| Струмица | Електро Клима | Братство-Единство 46 | 072 243 434 |
| Тетово | Стартер Фон | ул. 120 бр.10 | 044 333 590 |
| Тетово | Еко Клима ии | ул. 19-ти Ноември бр. 5 | 076 452 004 |
| Тетово | Фриго Нова | ул. Гостиварска бр.5 | 070 544 587 |
| Штип | Сервис Дени | Косовска 105 | 070 720 709 |
| Штип | Сервис Деспот | Милојкова 9 | 077 697 571 |

POŠTOVANI

Zahvaljujemo na kupovini Vivax uređaja i nadamo se da ćete biti zadovoljni izborom. Ako u periodu u kojem imate pravo na reklamaciju bude potreban popravak proizvoda, molim savetujte se sa ovlašćenim prodavačem koji Vam je proizvod prodao il/i nas kontaktirajte na dolje navedene brojeve i adrese.

MOLIMO VAS DA PRIJE UPOTREBE PROIZVODA PAŽLJIVO PROČITATE TE HNIČKU DOKUMENTACIJU I UPUTSTVA KOJI SU PRILOŽENI UZ PROIZVOD!

IZJAVA O SAOBRAZNOSTI

VIVAX

CG

MODEL UREĐAJA

SERIJSKI BROJ

DATUM PRODAJE

BROJ RAČUNA PRODAVCA

POTPIS I PEČAT PRODAVCA

| |
|--|
| |
| |
| |
| |
| |

1. Ovom izjavom o saobraznosti proizvođač proizvoda, preko KIM TEC CG d.o.o., kao uvoznika i davaoca prava u Crnoj Gori osigurava besplatan popravak istog u skladu s vazećim propisima i u skladu s uslovima opisanim u ovoj izjavi o saobraznosti.
 2. Ovom izjavom o saobraznosti ističemo da će predmet ovog prava raditi bez greške uzrokovane eventualnom lošom Izradom i lošim materijalom izrade. Svi eventualno nastali kvarovi biće besplatno otklonjeni u ovlašćenom servisu u predviđenom roku za reklamaciju.
 3. Rok za reklamaciju proizvoda počinje od dana kupovine proizvoda i traje **24 mjeseca**.
 4. **Rok za reklamaciju proizvoda u upotrebi produžuje se za sljedećih 12 mjeseci nakon izvršenja kontrolnog servisnog pregleda od strane ovlašćenog servisa.**
 5. **Rok za reklamaciju proizvoda može se produžavati ukupno tri puta, što u ukupnom trajanju može iznositi maksimalno 60 mjeseci**
 6. U slučaju kvara na proizvodu koji je predmet reklamacije, obavezujemo se da ćemo isti popraviti u najkraćem mogućem roku, a najkasnije u roku od 15 dana. Ako se proizvod ne može popraviti ili se ne popravi u roku od 15 dana, biće zamijenjen novim .
 7. Pravo na reklamaciju se priznaje uz fiskalni račun o kupovini, ili uz ovu izjavu o saobraznosti koji mora biti ispravno popunjen odnosno mora sadržati datum prodaje, pečat i potpis prodavca.
 8. Davalac izjave o saobraznosti osigurava servis i rezervne djelove u razumnom vremenskom periodu.
- PRAVO NA REKLAMACIJU NE OBUHVATA**
9. Redovnu provjeru, održavanje uz zamjenu dijelova koji se troše normalnom upotrebom. Prilagođavanje ili promjene za poboljšanje proizvoda za primjenu koje nijesu opisane u tehničkim uputstvima za korišćenje, osim ako je za te promjene predočena saglasnost KIM TEC CG d.o.o.
 10. Pravo na reklamaciju se ne priznaje u sljedećim slučajevima:
 - Ako kupac ne priloži ispravan reklamni list ili račun o kupovini.
 - Ako se kupac nije pridržavao uputstva o korišćenju proizvoda.
 - Ako je proizvod otvaran, prepravljan ili popravljan od neovlašćene osobe.
 - Ako su kvarovi na proizvodu nastali djelovanjem više sile kao što su: udar groma, strujni udaru u električnoj mreži elementarne nepogode i slično.
 - Ako su kvarovi nastali oštećivanjem zbog nepropisane upotrebe ili nepravilnim transportovanjem.
 - Ako je kvar nastao greškom u sistemu na koji je proizvod priključen.
 - Ova Izjava o saobraznosti ne mijenja zakonska potrošačka prava važeća u Crnoj Gori u odnosu na ona koja propisuje proizvođač

Naziv davaoca izjave o saobraznosti:

Kim Tec CG d.o.o. Ćemovsko polje bb, 81000 Podgorica, Crna Cora

Centralni servis (call centar):

Kim Tec CG d.o.o. Ćemovsko polje bb, 81000 Podgorica

Tel: 020/608-251,

E-mail za opšte upite: servisi@kimtec-ca.com

| | | |
|------------------------------------|--|--|
| DATUM SERVISNE INTERVENCIJE | | |
| DATUM POPRAVKA | | |
| DATUM SERVISNE INTERVENCIJE | | |
| DATUM POPRAVKA | | |
| DATUM SERVISNE INTERVENCIJE | | |
| DATUM POPRAVKA | | |

Ugradnja

| | |
|-----------------------|----------------------------------|
| DATUM UGRADNJE | OVLAŠĆENI SERVIS I POTPIS |
| | |

Servisni periodični pregled i održavanje:

| | |
|---------------------------|--------------------------|
| Servisni pregled 1 | Ovlašćeni servis: |
| Datum: | |
| Vrijedi do: | |
| Servisni pregled 2 | Ovlašćeni servis: |
| Datum: | |
| Vrijedi do: | |
| Servisni pregled 3 | Ovlašćeni servis: |
| Datum: | |
| Vrijedi do: | |

POPIS SERVISNIH MJESTA**VIVAX****CG**

| Grad | Servisi | Adresa | Telefon |
|-------------|----------------------|---------------------------|----------------------------|
| Podgorica | D-MK ŠĆEPANOVIĆ doo | Dalmatinska bb | 068-501-209 067-501-209 |
| Podgorica | KLIMA M doo | Miladina Popovića 155 | 067-261-535 |
| Podgorica | TmušićTermo Tehnika | Pavla Mijovića bb | 067-181-482 |
| Bar | FRIGO TIM doo | Bulevar DJ.K.Skenderbega | 069-312-312 030-411-999 |
| Bar | NS ELEKTRONIX doo | Bjeliši bb | 069-527-638 |
| Budva | NS ELEKTRONIX doo | Bjeliši bb | 069-527-638 |
| Herceg novi | MILMONT doo | V Crnogorske brigade br.5 | 067-584-922 |
| Herceg novi | KOMPRESOR doo | Njegoševa 150 | 031 -323-503 |
| Herceg novi | KOROVljeVIĆ doo | Zelenika, Kuti bb | 067-606-099 |
| Kotor | TERMOSTIL doo | Vidikovac bb | 067-232-632 |
| Niksic | ElkoFrigoTeam doo | Miolje polje bb | 068-000-701 |
| Tivat | SERVISCOMMERC D.O.O. | Nikole durkovića | 032-674-619 |
| Ulcinj | FRIGO TIM doo | Bulevar DJ.K.Skenderbega | 069-312-312 030-411-999 |

TË NDERUAR BLERËS

Faleminderit për blejjen tuaj dhe shpresoj se ju do të jenë të kënaqur me përzgjedhjen. Nëse periudha e garantonit është e nevojshme për të riparuar produktin, ju lutem konsultohuni me shitësin

Apo me me personin i cili jua shet produktin tone

JU LUTEM LEXONI ME KUJDES PARA PËRDORIMIT PRODUKTIT DOKUMENTET TEKNIKE DHE MANUALET CILAT JANË VENDOSUR NË KUTI

LETGARANCIONI

VIVAX

KS

EMRI PRODUKTIT

LLOJI DHE MODELI

PRODHUESI

EMËRTIMI APO EMRI 1

SHITËSIT

NUMRI SERIAL

DATA SHITJES

| |
|--|
| |
| |
| |
| |
| |
| |
| |
| |

VU LA:

NËNSHKRIMI I PËRSONIT ZYRTAR:

1. Kjo fletgarancion ju garanton që prodhuesi, nëpërmjet AskTec Ltd, si nje importues dhe ofrues i sigurisid ne Republikën e Kosovës, një riparim të lirë të njëte në përputhje me rregullat e zbatueshme në pajtim me kushtet e përshkruara në këtë fletgarancion .

KUSHTET E GARANCIONIT:

- Periudha e garancisë fillon nga dita e blerjes së produktit dhe periudha e garancisë është **24 muaj**, me përjashtim të modeleve: **ACP-xxxxCCxxxx, ACP-xxxxCTxxxx, ACP-xxxxDTxxxx, ACP-xxxxCFxxxx, ACP-xxxxFSxxxx** është **12 muaj**.
- Garancia për pajisjet në përdorim mund të zgjatet edhe për **12 muaj të tjerë pasi shërbimi i garancisë është kryer nga një qendër shërbimi e autorizuar.**
- Garancia mund të zgjatet tre herë, gjithsej tre herë me radhë, me përjashtim të modeleve **ACP-xxxxCCxxxx, ACP-xxxxCTxxxx, ACP-xxxxDTxxxx, ACP-xxxxCFxxxx, ACP-xxxxFSxxxx** maksimumi katër herë radhazi.
- Kjo fletgarancion, ne garantojmë se ju do të jetë subjekt i kësaj pune garancisë pa gabime të mundshme të shkaktuara nga mjeshtëri e profesionalizuar dhe të materialit të dobët. Të gjitha gabimet mund të ndodhin ne do t korrigjohen pa pagesë në një shërbim garancion të autorizuar.
- Në rast prishjes produktit do të mbulohet nga ky garancion , zotohemi për të rregulluar njëjtin sa më shpejt të jetë e mundur, dhe jo më vonë se 30 ditë. Nëse produkti nuk mund të riparohet ose nuk riparohet brenda 30 ditëve, ajo do të zëvendësohet.
- Nëse procedura riparimit zgjat më shumë se 10 ditë, garancioni do të shtyhet për kohëzgjatjen e riparimit.
- Garancioni është e njohur vetem me një faturë të shitjes, dhe me kartën e garancionit e cila duhet të plotësohet si duhet dhe duhet të përfshijë datën e shitjes, vula dhe nënshkrimi shitësit.

9. GARANCIONI NUK MBULON:

Inspektimit të rregullt, mirëmbajtjenndrrimi i pjesve hargjuese.

Rregullim ose ndryshim në përmirësimin e produktit për zbatimin që nuk janë përshkruar në udhëzimet teknike për përdorim, përveç modifikime paraqitura Me pëlqimi AskTec LLC

10. Garancioni nuk pranohet në këto raste :

Nëse një klienti nuk paraqet kartën e saktë garancionit dhe faturë blerse. Në qoftë se bleresi nuk përbush udhëzimet mbi përdorimin e produktit.

Nëse produkti është i hapur, modifikuar ose riparuar nga personi i paautorizuar.

Nëse dështimet produktit janë shkaktuar nga forcës madhore, të tilla si rrufeja, electriciteti në fatkeqësitë e rrjetit elektrike .

Nëse dështime shkaktuar dëme nga përdorimi i pavend ose transportit të pahijshme.

Nëse defekt është një defekt në sistemin në të cilën produkti është i lidhur.

Ask Tec d.o.o.

Tahir Zajmi (Kosova tex), 10000 Prishtina

Tel: +383 38 771 001

E-mail: info@asktec-ks.com, Web: www.asktec-ks.com

| | | |
|------------------------------|--|--|
| DATA PRANIMIT PAISJES SERVIS | | |
| DATA RIPARIMIT | | |
| DATA PRANIMIT PAISJES SERVIS | | |
| DATA RIPARIMIT | | |
| DATA PRANIMIT PAISJES SERVIS | | |
| DATA RIPARIMIT | | |

Instalimi

| | |
|-------------------|--------------------------------------|
| DATA E INSTALIMIT | SHËRBIMI DHE FINSHKRIMI I AUTORIZUAR |
| | |

Inspektimi dhe mirëmbajtja periodike e shërbimit:

| | |
|---------------------------|--|
| Inspektimi i shërbimit 1 | |
| Data: | |
| Skadon: | |
| Inspektimi i shërbimit 2 | |
| Data: | |
| Skadon | |
| Inspektimi i shërbimit 3 | |
| Data: | |
| Skadon | |
| Inspektimi i shërbimit 4* | |
| Data: | |
| Skadon | |

* Shërbimi i Inspektimit 4 është i vlefshëm vetëm për modelet me një garanci bazë 12-mujore.

| City | Company | Adress | Phone |
|------------------------------|--------------------|--------------------------------------|-------------|
| Prishtine-Fush Kosove-Lipjan | Eko Electronics | Vëllezërit Fazliu Nr. 74 | 045553800 |
| Prishtine-Fush Kosove-Lipjan | Unique | Rr. Isa Kastrati p.n Kompleksi ARKOS | 049111499 |
| Ferizaj | Termo Ylli | | 044677077 |
| Gjilan-Viti | Toni-Impex | 28 Nentori nr 60 | 044 490 939 |
| Mitrovice | Kulla | Ahmet Maloku 60 | 049307307 |
| Peje | Uraniku | Vitomerice | 049178749 |
| Peje | CTA | Sahit Bakalli nr. 24 | 049506447 |
| Gjakove | Lila Tech | Rr. Skenderbeu | 048116811 |
| Prizren-Suharek-Malisheve | Perfect Service | Lidhja e dukagjinit | 048166141 |
| Prizren-Suharek-Malisheve | Miranda- X-Tronics | Prizren | 044140434 |
| Kosove | Xhela Gorenje | Drenas | 048170700 |

sSPOŠTOVANI KUPCI!

Zahvaljujemo se vam za nakup Vivax klimatske naprave. Upamo, da boste z izbiro zadovoljni.

PROSIMO, DA PRED UPORABO PROIZVODA NATANČNO PREBERETE TEHNIČNO DOKUMENTACIJO TER PRILOŽENA NAVODILA ZA UPORABO

GARANCIJSKI LIST

VIVAX

SLO

| | |
|--|---|
| Številka Garancije oz Računa | |
| Tip naprave: | |
| Datum prodaje/pričetka veljavnosti garancije | |
| Zunanja enota | |
| Notranja enota | 1 |
| | 2 |
| | 3 |
| Kraj prodaje/trgovina | |
| Žig in podpis trgovke-ca | |

S to garancijo vam proizvajalec zagotavlja, preko podjetja SCARa-Tec d.o.o., kot uvoznika in izdajatelja garancije v Republiki Sloveniji, brezplačno popravilo naprave, v skladu z veljavnimi predpisi ter pogoji, opisanimi v tem garancijskem listu.

GARANCIJSKI POGOJI

1. Prevzemamo odgovornost brezplačnega popravila ali zamenjave nedelujočih delov, ki bi nastali v obdobju trajanja garancije zaradi napake med izdelavo ali instalacijo.
2. Garancijski rok začne teči od dneva nakupa izdelka in traja **24 mesecev**, razen za model **ACP-xxxxCCxxxx, ACP-xxxxCTxxxx, ACP-xxxxDTxxxx, ACP-xxxxCFxxxx, ACP-xxxxFSxx**, ki velja **12 mesecev**.
3. Garancija za naprave v uporabi se podaljša za nadaljnjih **12 mesecev po opravljenem garancijskem servisu v pooblaščenem servisu**.
4. Garancija je mogoče skupaj **podaljšati trikrat, razen za model ACP-xxxxCCxxxx, ACP-xxxxCTxxxx, ACP-xxxxDTxxxx, ACP-xxxxCFxxxx, ACP-xxxxFSxxxx**, za katero se garancija lahko podaljša za **največ štirikratno obdobje (največ 60 mesecev)**.
5. Garancijski in servisni pregled zaračunava pooblaščeniseriser po ceniku zastopnika podjetja. Ob servisu naprave, pooblaščeniseriser potrdi garancijski list in s tem podaljša veljavnost garancije.
6. Garancija velja v primeru, ko je vgradnja ali servis Vivax klimatskih naprav opravljena s strani pooblaščenega serviserja, katerega je pooblastil zastopnik, podjetje SCARa-Tec d.o.o., Gozdna ulica 2C, Spodnje Hoče, 2311 Hoče
7. Vivax klimatsko napravo, kot celoto, sestavljajo notranja(e) enota(e), instalacija in zunanja enota, ki so pravilno izbrani in, ki so glede na model in moč kompatibilni.
8. V primeru okvare Vivax klimatske naprave se obvezujemo, da bomo napravo v najkrajšem možnem času popravili, zagotovo pa v roku 45 dni. Če se Vivax Cool klimatska naprava ne more popraviti ali se ne popravi v roku 45 dni od vloge reklamacije, jo zamenjamo z novo. Če popravilo traja dlje od 10. dni, se garancijski rok podaljša za dolžino obdobja popravila.
9. Garancija se prizna le s priloženim računom ter garancijskim listom, ki mora biti pravilno izpolnjen in potrjen s strani prodajalca, pooblaščenega monterja ali serviserja. Izdajatelj garancije zagotavlja servis, ter rezervne dele 4 leta od datuma nakupa Vivax Cool klimatske naprave.
10. **Pod garancijo ne spadajo okvare** nastale zaradi nepravilne priključitve v električno omrežje, napetostnega udara, udara strele ali drugih nesreč, nastalih zaradi slabega vremena ter višje sile.
11. Garancija ne velja za okvare, ki so nastale zaradi nepazljive ali nestrokovne uporabe ter neupoštevanja navodil za uporabo, tj. zaradi kakršnekoli okoliščine, katera se ne more pripisati napaki v izdelavi klimatske naprave. Ob vgradnji, servisiranju, pregledovanju ali popravilu Vivax klimatske naprave s strani nepooblaščenega servisa, delavnice ali tretje osebe, kupec Vivax klimatske naprave izgubi pravico do uveljavljanja garancije. Iz garancije je izključena odgovornost za morebitne poškodbe oseb ali živali oz. kakršnekoli škode, ki bi lahko nastale med delovanjem ali nedelovanjem klimatske naprave.
12. Garancijski kuponi služijo uveljavljanju popravila naprave. V primeru popravila ima servis pravico zadržati en garancijski kupon. Opozorilo: garancija ne izključuje pravic potrošnika, ki izhajajo iz odgovornosti prodajalca za napake na blagu. Garancija velja za celotno območje Republike Slovenije.

Naziv podjetja, ki je izdalo garancijo:

SCArA-Tec d.o.o., Gozdna ulica 2C, Spodnje Hoče, 2311 Hoče

Tel.: +386 2 618 52 08

Centralni servis:

SCArA-Tec d.o.o., Gozdna ulica 2C, Spodnje Hoče, 2311 Hoče

| |
|------------------|
| Ime, priimek |
| Telefonska št.: |
| Naslov: |
| E-mail: |
| Datum vgradnje: |
| Serviser/monter: |
| Žig in podpis |

| |
|--|
| |
| |
| |
| |
| |
| |
| |

| |
|------------------------------------|
| DATUM SPREJEMA NAPRAVE V SERVIS |
| DATUM POPRAVILA |
| DATUM SPREJEMA NAPRAVE V SERVIS |
| DATUM POPRAVILA |
| DATUM SPREJEMA NAPRAVE V SERVIS |
| DATUM POPRAVILA |

| | |
|--|--|
| | |
| | |
| | |
| | |
| | |
| | |

Servisno vzdrževanje:

| |
|----------------------------|
| Servisni pregled 1 (datum) |
| Serviser/monter: |
| Žig in podpis |

| |
|--|
| |
| |
| |

| |
|----------------------------|
| Servisni pregled 2 (datum) |
| Serviser/monter: |
| Žig in podpis |

| |
|--|
| |
| |
| |

| |
|----------------------------|
| Servisni pregled 3 (datum) |
| Serviser/monter: |
| Žig in podpis |

| |
|--|
| |
| |
| |

| |
|-----------------------------|
| Servisni pregled 4* (datum) |
| Serviser/monter: |
| Žig in podpis |

| |
|--|
| |
| |
| |

* Servisni pregled 4 velja samo za modele z osnovno 12-mesečno garancijo

| Mesto - regija | Podjetje-montažer | E-mail | Telefon: |
|--------------------------------|--|-----------------------------------|-------------------------------|
| Ljubljana z okolico | Tomaž Oman TO s.p. | to@siol.com | 031/ 359 921 |
| Ljubljana z okolico | Klima Blatnik, Jože Blatnik s.p. | klima.blatnik@yahoo.com | 031/ 394 694 |
| Ljubljana z okolico | Elsan, Aleksander Ponikvar s.p. | aleksander.ponikvar@siol.net | 041/ 683 121 |
| Ljubljana z okolico | Kniss d.o.o. | luka.bizjak@gmail.com | 031/ 406 704 |
| Ljubljana z okolico | Klima ELEKTRO d.o.o. | info@klimaelektro.si | 01/ 600 32 91 080/ 33-38 |
| Ljubljana z okolico | Elektro Čepon d.o.o. | info@elektro-cepon.si | 031/ 427 446 |
| Ljubljana z okolico | VENALIA d.o.o. | info@venalia.si | 0590 51 840 |
| Ljubljana z okolico | PERAL, Alojz Perme s.p. | info@mojaklima.si | 031/ 669 888 |
| Ljubljana z okolico | Kapitan d.o.o. | kapitan@telemach.net | 041/ 728 344 |
| Ljubljana z okolico, Dolenjska | Žibert Vincenc s.p. | vine.zibert@gmail.com | 041/ 647 519 |
| Ljubljana z okolico, Dolenjska | Martina Župevec s.p. | martina.zupevec@siol.net | 031/ 681 462 041/ 618 201 |
| Ljubljana z okolico, Dolenjska | Klira d.o.o. | info@klira.si | 051/ 360 180 |
| Ljubljana z okolico | BCE Group d.o.o. | info@bce-group.si | 070/ 147 022 030/ 335 184 |
| Dolenjska | KLIMAJ d.o.o. | info@klimaj.si | 040/ 830 500 |
| Dolenjska, Bela krajina | Tema d.o.o. | maljavec.jure@gmail.com | 041/ 731 173 |
| Štajerska | SCArA-Tec d.o.o. | Bostjan.pomer@scara-tec.si | 051/ 380 529 02/ 618 52 05 |
| Štajerska | T&L, Kristijan Rodić s.p. | tlstoritve@gmail.com | 040/ 148 108 |
| Štajerska | Hardstore d.o.o. | urh@hardstore.si | 041/ 265 167 |
| Štajerska | Tepeh Boris s.p. | servis.tepeh@siol.net | 041/ 364 731 02/ 462 52 80 |
| Štajerska | Klima efekt d.o.o. | klimajost@gmail.com | 040/ 291 381 |
| Štajerska | Dušan Krk s.p. | info@klimanaprave.si | 070/ 504 505 |
| Štajerska, Kozjansko | Elektronika Matic Supovec s.p. | ivo.supovec@gmail.com | 041/ 452 305 |
| Pomurje | PEGAS trg. in storitve Ljutomer d.o.o. | pegasdoo@siol.net | 041/ 623 728 |
| Idrija | Marinac Roko s.p. | roko.marinac@siol.net | 041/ 479 282 |
| Ptuj | Klima Ptuj d.o.o. | info@klima-ptuj.com | 02/ 779 80 70 |
| Ptuj | IBLO podjetje za trg. in storitve d.o.o. | dejan.lovrec@iblo.si | 041/670 102 |
| Gorenjska | BCE Group d.o.o. | info@bce-group.si | 070/ 147 022 030/ 335 184 |
| Gorenjska | PERAL, Alojz Perme s.p. | info@mojaklima.si | 031/ 669 888 |
| Gorenjska | Tomaž Oman TO s.p. | to@siol.com | 031/359 921 |
| Gorenjska | Hvac d.o.o. | nitrorider.andrej@gmail.com | 041/ 675 548 |
| Zasavsko-posavska regija | Pos-DEJ d.o.o. | pos-dej@t-2.net | 040/ 223 224 |
| Primorska | Martina Župevec s.p. | martina.zupevec@siol.net | 031/ 681 462 041/ 618 201 |
| Primorska | Hlad. in toplot. tehnika Milan Prica s.p | hladilne-naprave@siol.net | 041/ 799 589 |
| Primorska | Dantes Trošt s.p. | dantes.trosth@siol.net | 041/ 323 284 |
| Štajerska, Kozjansko, Pomurje | Danijel Toplišek s.p. | trgovina.servis.toplisek@siol.net | 031/ 681 114 |
| Koroška | HOT Hlajenje in ogrev. Jeromel Tone | tone@jeromel.si | 041/ 601 712 |



VIVAX

www.VIVAX.com